

DH603

Hydrogen Determination

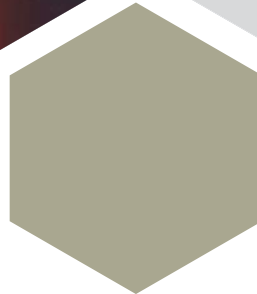

LECO
EMPOWERING RESULTS

DH603 Hydrogen Determination

Get fast, high-precision residual, diffusible, and total hydrogen determinations with the DH603. This instrument determines the amount of residual hydrogen (or diffusible and residual hydrogen when equipped with the optional integrated sample piercer) present in ferrous alloys. A small footprint, external PC with user-friendly operating software, and increased instrument safety and robustness are all a part of the advanced DH603 design.



DH603 Advantages

A variety of features have been constructed into the design of the DH603 to answer the needs of our customers.

- Exclusive ECLIPSE architecture—a unique design by LECO that improves reliability and serviceability
- Improved plumbing—streamlined and efficient for faster maintenance of flow path
- Accessible components—easily accessible to the operator thanks to ergonomic shells
- Fixed furnace—more robust than tilting and vibrating designs
- Advanced furnace control system—allows temperature ramping from ambient to 1100 °C
- Optional diffusible sample piercer—choice of diffusible/residual/total hydrogen determination
- Gas dose calibration—allows calibration without reference materials

Additional Software Features

- Blank and drift correction
- Scheduled wake-up feature to allow timed instrument start-up, reducing equilibration time
- Ethernet LAN protocol
- Expanded service diagnostics, including compatibility to ~~SmartLine~~ Remote Diagnostics
- Software supports data validation with electronic signature

Thermal Conductivity Detection

State-of-the-art TC detector offers greater signal-to-noise ratio, lower detection limits, improved stability, and expanded dynamic range to minimize maintenance and enhance operator flexibility

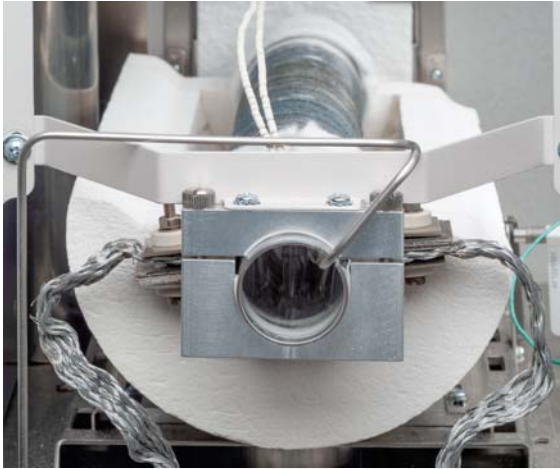
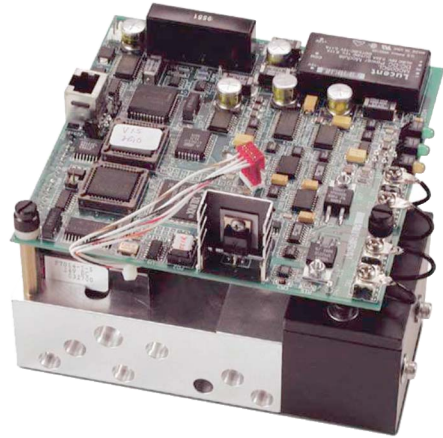

Improved Furnace Reliability

LECO designed furnace system is more robust, stationary, and housed within the ergonomic shell—decreasing maintenance and improving reliability and safety

Variety of Sampler Options

LECO offers a variety of evacuated pin tubes and diffusible samplers for quick and easy hydrogen determination of molten metals



Optional Diffusible Piercer

Integrated system features long-life needles and seals improving reliability and precision

Easy-to-Use Operating Software

Simplified data handling, customizable data reporting/exporting, and a number of user-defined settings make the DH603 software flexible and easy to operate. With virtually unlimited storage space and compatibility with various Laboratory Information Management Systems (LIMS), this software is designed for seamless interaction with any operator or customer environment. A convenient on-board help manual allows quick access to information without leaving the instrument. Compatible to **SmartLine®** Remote Diagnostics application.

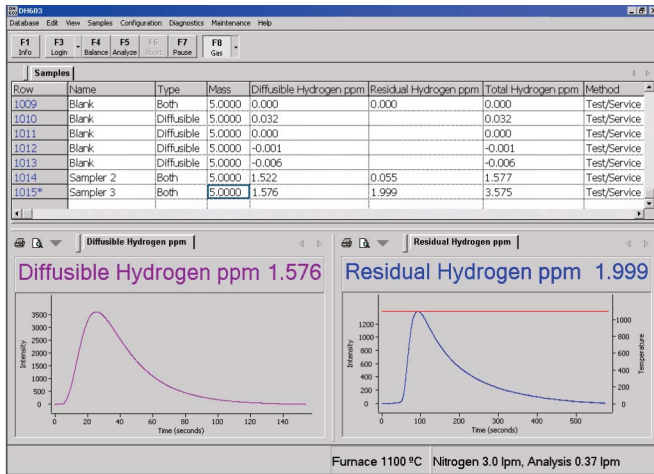

Manage data and graphs seamlessly.

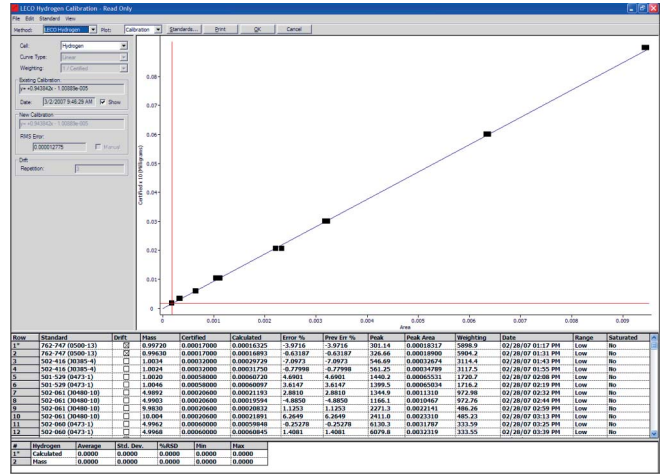

Perform simple calibrations and drift corrections.

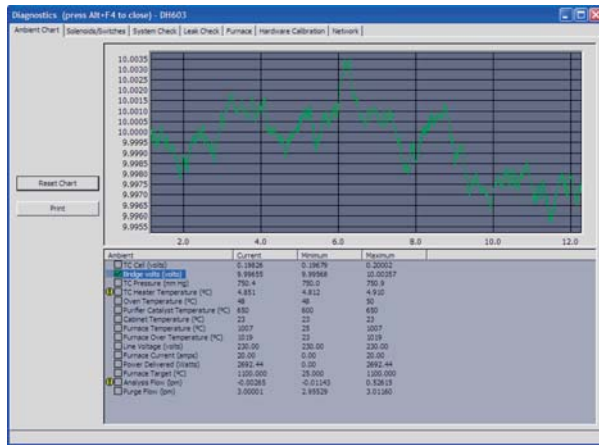

Monitor internal components during analysis.

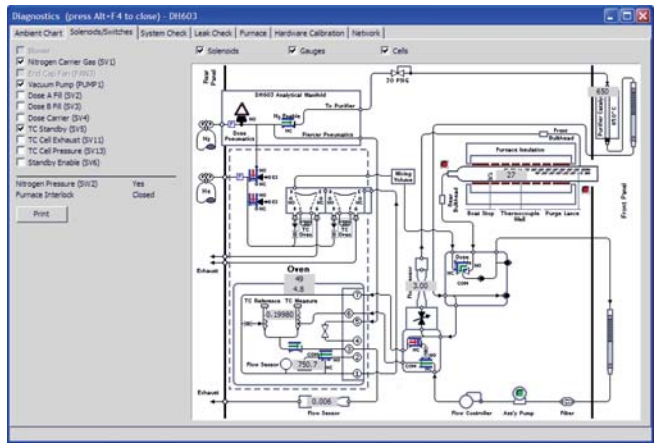

Expanded interactive diagnostic screens help troubleshoot problems faster and easier.

LECO—Your source for total analytical solutions

CS744
Carbon/Sulfur
by Combustion



GDS900
Glow Discharge
Spectrometer



3000 Lakeview Avenue | St. Joseph, MI 49085 | 800-292-6141 | Phone: 269-985-5496
info@leco.com | www.leco.com | ISO-9001:2015 Q-994 | LECO is a registered trademark of LECO Corporation.

LECO

EMPOWERING RESULTS
© 2019 LECO Corporation