

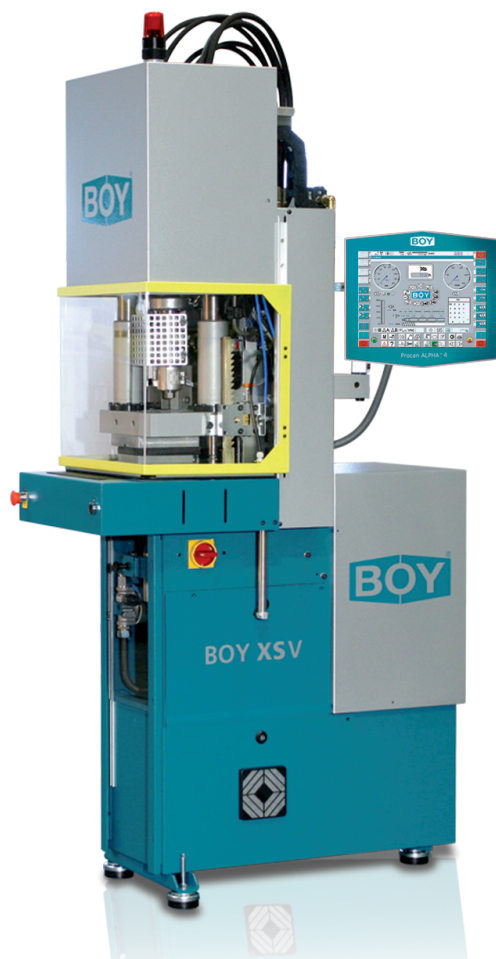

Spritzgiessautomaten

Innovative into the Future – BOY-Injectioneering



Insert moulding machine **BOY XS V**

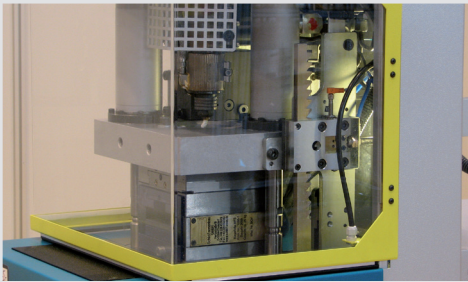

Diagonally arranged tie bars facilitate the installation also of larger moulds

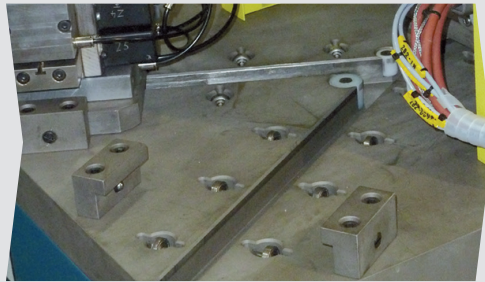

Manual sliding table (e.g. with linear or Y-axis)

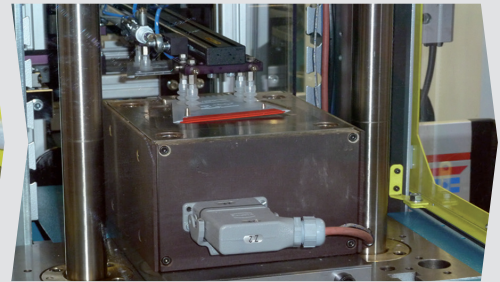

Automated insertion/removal of overmoulded parts from the rear machine table

- Maximum performance in smallest space
- Ultra-compact insert moulding machine with diagonally arranged tie bars.
- The fixed lower platen inhibits a shifting of the insert parts during mould closing
- Best possibilities for inserting and evacuating the parts
- Extremely low space requirement (0.64 m²)

The basic concept of the BOY XS V is identical to the BOY XS, except the injection and clamping units are **arranged vertically**.

The clamping unit features two **diagonally** arranged tie bars, which ensures easy access to the mould area.

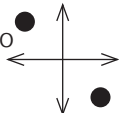

Highly precise applications, smallest dimensions as well as much **free space** for peripheral devices are the decisive advantages of the BOY XS V.

The free machine table behind the injection unit can be used for the positioning of **automation equipment**. Different feeding and removal automations can be integrated space saving and without additional space requirement (see following picture).



It is powerful in **industrial continuous operation** and optimally suitable for fully automatic insert moulding of insert parts and integration into production lines.

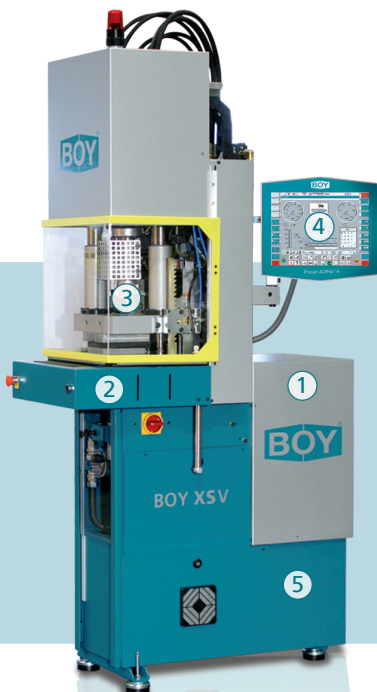

- 1 The machine design features the best ergonomics and efficient operation.
- 2 The fixed lower platen is characteristic for all BOY insert moulding machines. This prohibits shifting of inserted parts during closing and opening of the mould.
- 3 Diagonally arranged tie bars facilitate the installation also of larger moulds.
- 4 Optimum control technology with intuitive operation concept.
- 5 Robust machine design with integrated oil tank.

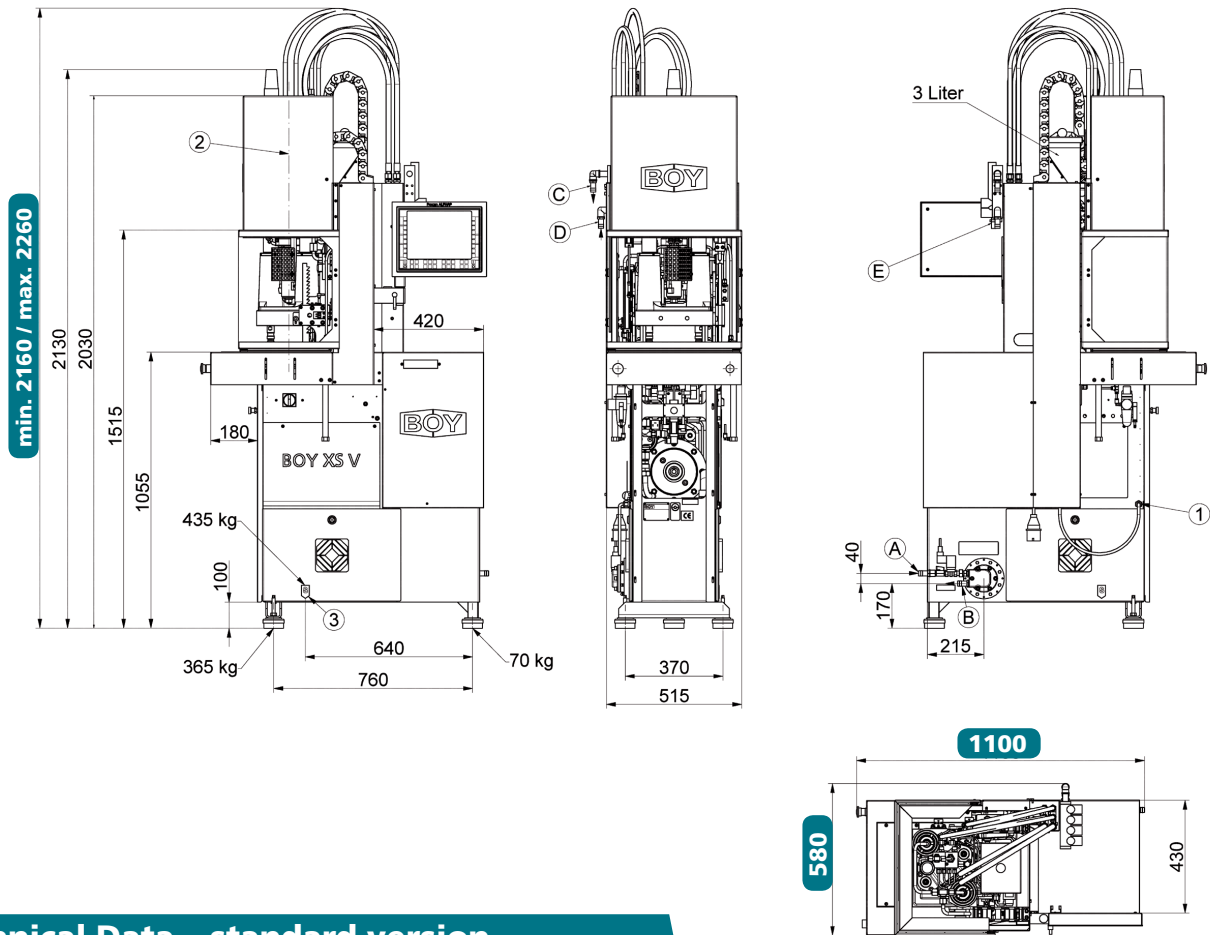

Technical Data – standard version

Injection unit for processing thermoplastics		SP 3 ¹		SP 14	
Screw diameter	mm	8	12	14	16
Screw- L/D-ratio		22	19.7	16.9	14.6
Max. stroke volume (theoretical)	cm ³	1.0	4.5	6.1	8.0
Max. shot weight in PS (theoretical)	g	1.14	4.1	5.6	7.3
Injection force	kN	12.7	35.4	35.4	35.4
Injection flow (theoretical)	g/s	4.02	20.7	28.3	36.8
Max. spec. injection pressure	bar	2534	3128	2298	1760
Max. screw stroke	mm	20	40	40	40
Nozzle force / contact pressure	kN	10	20	20	20
Nozzle retraction stroke	mm	100	100	100	100
Screw torque	Nm	12.5 (25 bar)	50 (75 bar)	75 (115 bar)	100 (150 bar)
Screw speed (infinitely variable)	U / min.	max. 340	max. 340	max. 340	max. 340
Screw pulback force	kN	5	5	5	5
Heating power (nozzle + cylinder)	W	1335	1825	1825	1825
Hopper capacity	litre	3	3	3	3

Clamping unit

Clamping force	kN	100
Distance between tie bars	mm (h x v)	160 (diagonal 205)
Max. daylight between platen	mm	250 (optional 200)
Max. opening stroke (adjustable)	mm	150
Min. mould height	mm	100 (optional 50)
Max. mould weight on moveable clamping side	kg	22
Mould opening force	kN	15
Mould closing force	kN	10
Ejector stroke (max.)	mm	50
Ejector force pushing / pulling	kN	8.4 / 8.4

General

Installed driving power / total power	kW	3.0 / 4.83 (400 V)
Duration of the dry cycle (EUROMAP 6)	s – mm	1.5 – 112
Hydraulic system pressure	bar	300
Oil tank capacity	litre	28

Dimensiones and weights

		BOY XS V
Dimensions (LxWxH) / Footprint	mm / m ²	1100 x 580 x 2160 ² / 0.64
Total weight net (without oil)	kg	457
Total weight gross (pallet & foil / wooden case)	kg	507 / 647
Transport dimensions / case (LxWxH) approx.	m	- / 1.7 x 0.7 x 2.25

1) not suitable for all materials; applicability on request

2) max. 2260 mm



Procan ALPHA®

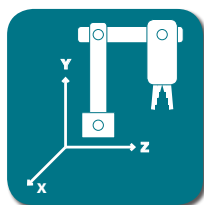

Automation

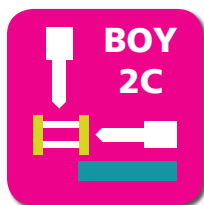

Multi Component



Made in Germany

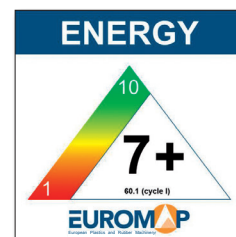

The specified efficiency classification is achievable depending on the respective machine equipment.

Equipment

Injection unit

Pivoting injection unit	-
Preset screw speed values with ramping transition	■
Cold start protection	■
Number of set points of injection speed	8
Number of set points of injection pressure	2
Start of holding pressure dependent on hydraulic pressure, stroke and time	■
Start of holding pressure, cavity pressure-dependent	□
Number of set points of holding pressure	8
Production monitoring at start of holding pressure	■
Closed loop control for the complete injection profile and back pressure	■
Control for intrusion-injection	-
PID microprocessor-controlled heating zones for cylinder + nozzle set and temp. display	2+1 □
Hydraulically actuated needle shut-off nozzle (pneumatic for XS-LSR)	○
Slide-away for quick material change (25/35/55 VV / 35 HV / 2C M / L without hopper)	-
Automatic material loader / feeder	□
Adjustable nozzle force	■
Delayed nozzle retraction	■
Servo-electric screw drive (separate feed line required)	-
High wear-resistant plasticizing units	-
High wear-resistant EconPlast unit	-
Speed injection	-

Clamping unit

Reduced mould height by 50 mm	□
Moving platen support to improve the precision when using large moulds	-
Number of set points of mould closing speed / opening speed	8/8
Number of reopening attempts after mould closing	■
Hydr. ejector with dig. adjustable pressure, speed, position + no. of strokes, intermediate stop position	■
Hydraulic ejector with adjustable stroke 50 mm	■
Hydraulic ejector with adjustable stroke 130 mm	-
Hydraulic ejector with adjustable stroke 150 mm and 42,7 kN force	-
Hydraulic unscrewing device, one or two directions of rotation with intermediate stop	-
Hydraulic unscrewing device, two directions, proportional valve and pulse generator	-
Core pull control with 4/3 way directional control valve and freely selectable operational programmes	□/-
Injection compression (coining) and breathing with mould degassing control	-
Hydraulic guard safety device	■
Self adjusting mechanical drop bar safety system with electronic monitor	■
Safety gate for handling devices	-
Electronically operated safety gate	-
Selection flap	-
Air ejection	□
Mould lifting crane	-
Simultaneous ejector movement (with double pump)	-
Integrated sprue picker	-

Electronics

USB interface for access and data exchange	■
Interface kit: Serial/Temperature device, USB/Printer and Ethernet	□
OPC interface	□
4 freely programmable inputs/outputs	□
Piece counter / interval signal	■
Preselect cycle counter with auto shut-off	■
Grounded socket outlet 230 V ~ / 10 A (alternatively can be switched off)	■(-)
CEE socket outlet 400 V ~ / 16 A (alternatively can be switched off)	-(-)
Socket distributor 400 V ~ switched + 230 V ~ (Standard supply 32 A)	□
Energy distributor with four fixed connections, up to 5 x 400 V CEE + 3 x 230 V (sockets can be switched off optionally). Standard supply 125 A / 5 x 50 mm²	-
Switch cabinet ventilation	■
Standardized interface for handling units (EUROMAP 67)	□
Separate feeder (heating and motor current)	-
7-day timer	■
Additional temperature control	□
Brush control	□
Connector for safety switch to inhibit mould closing	□
Integrated hot runner control, 8/16-fold (separate feed line required)	-
Air conditioning unit for control cabinet	-
Alarm signal with sound	□

Hydraulics

Electronically controlled variable pump	■
Servo-motor pump drive (Servo-drive)	-
Oil preheating circuit automatic	■
Oil temperature gauge / Controlled oil cooling / Oil level indicator	■
Oil level and temperature monitoring	■
Optical oil filter contamination indicator	-
Proportional action valve for the clamping unit	-
Proportional valve with stroke feedback and positioning action for clamp unit	-

General

Cooling water distributor with electric shut-off valve for injection mould	-
Temperature control for feed throat	□
6- / 8-zone water distributor	-
Tool kit	□
Spare parts package	□
Oil filling	□
Anti-vibration mounts	■

■ standard ○ alternatively □ optional - not available

You would like to learn more about this BOY injection moulding machine?



Data and Equipment (complete overview)



Competence brochure



Dr. Boy GmbH & Co. KG

Industriegebiet Neustadt / Wied
Neschener Str. 6
53577 Neustadt-Ferndal
Germany

Phone: +49 (0)2683 307-0
Fax: +49 (0)2683 307-4555
E-Mail: info@dr-boy.de
Internet: www.dr-boy.de



BOY-APP
free of charge at
http://app.dr-boy.de

