



Spritzgiessautomaten

Innovative into the Future – BOY-Injectioneering

**Now with
Procan ALPHA 2**



Injection moulding machine **BOY 22 A PRO**

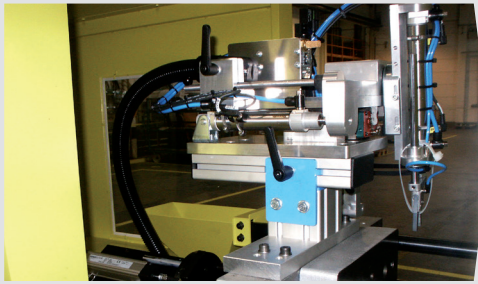

Sprue and removal pickers integrated under the safety housing

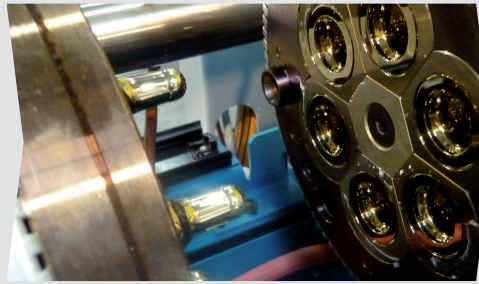

Production of silicone pacifiers with two-component silicone (LSR)

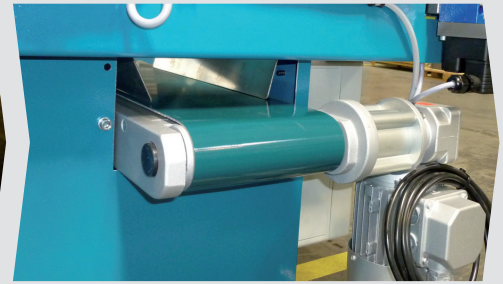

Optional sorting conveyor – integrated in the trip chute

- Attractive price/performance ratio
- Robust, well thought-out design
- High efficiency through low machine hour rates
- Generous mould mounting dimensions with additional mounting possibilities (Pitch circle diameter of 170 mm; hole Ø 12.5 mm)

The BOY 22 A **PRO** is a ruggedly designed injection moulding machine constructed for industrial continuous operation and longevity.

The very compact injection moulding machine (merely 2.1 m²) features a cantilevered clamping unit which offers optimal accessibility and parts removal.

Equipped with 220 kN clamping force and an energy-saving, electronically controlled variable displacement pump as well as the multipatented Procan ALPHA screen control, the BOY 22 A **PRO** delivers efficient production in a compact space.

Even in comparison to older machine generations, the BOY 22 A **PRO** is impressive in its low energy consumption and faster cycle times.

In addition to the injection units 11 and 15, the injection unit SP 52 with a total of seven screw diameters offers a wide range of possible applications.

Additionally, there is a large range of options that complete the BOY 22 A **PRO** package.

In particular, an optional integrated handling interface and picker are available that can be positioned under the safety gate. The optional EUROMAP 12 handling interface is also available.

Technology development of BOY 22 A PRO

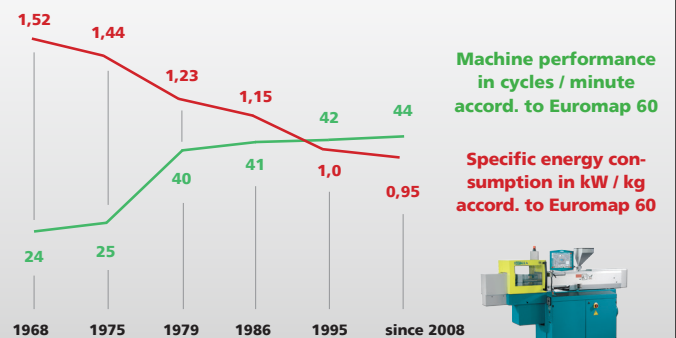

- 1 The machine design features the best ergonomics and efficient operation.
- 2 The ejector chute, open on three sides, guarantees optimum removal of the moulded parts.
- 3 Easy handling and flexibility with regard to additional equipment due to the cantilevered clamping system.
- 4 Optimum control technology with intuitive operation concept.
- 5 Robust machine design with integrated oil tank.

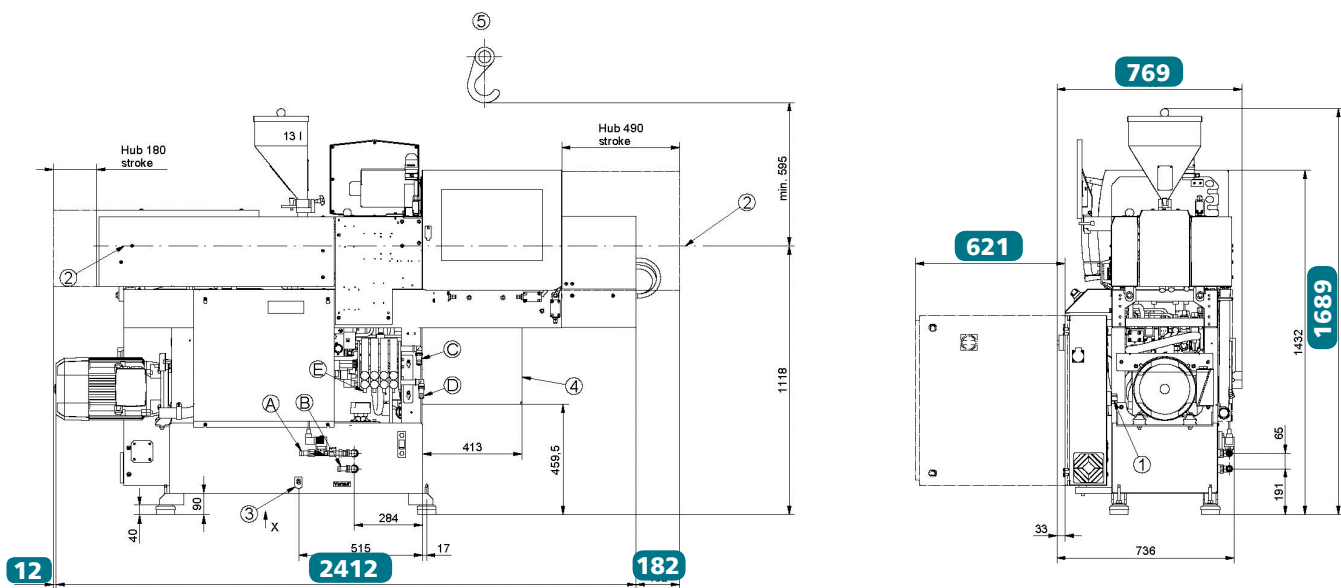

Technical Data – standard version¹⁾

Injection unit for processing thermoplastics		SP 11	SP 15	SP 52				
Screw diameter	mm	12	14	18	22	24	28	32
Screw- L/D-ratio		18	18	20	17.5	22	18.6	16.3
Max. stroke volume (theoretical)	cm ³	4.5	6.1	20.4	30.4	36.2	49.3	64.3
Max. shot weight in PS (theoretical)	g	4.1	5.6	18.6	27.7	32.8	44.6	58.2
Injection force	kN	27.7	37.1	65.8	65.8	65.8	65.8	65.8
Injection flow (theoretical)	g/s	14.6	19.9	33.0	49.2	58.2	79.2	103.3
Max. spec. injection pressure	bar	2450	2413	2587	1732	1455	1069	818
Max. screw stroke	mm	40	40	80	80	80	80	80
Nozzle force / contact pressure	kN	48	48	48 / 36 [HV]	48 / 36 [HV]	48 / 36 [HV]	48 / 36 [HV]	48 / 36 [HV]
Nozzle retraction stroke	mm	180	180	180	180	180	180	180
Screw torque	Nm	50 (75 bar)	75 (68 bar)	130 (120 bar)	180 ² / 290 ³	180 ² / 290 ³	180 ² / 290 ³	180 ² / 290 ³
Screw speed (infinitely variable)	U / min.	500	500	500	400 ² / 250 ³	400 ² / 250 ³	400 ² / 250 ³	400 ² / 250 ³
Screw pulback force	kN	22.2	30.6	30.6	30.6	30.6	30.6	30.6
Heating power (nozzle + cylinder)	W	2200	2560	3250	3550	5800	5800	5800
Hopper capacity	litre	7.5	7.5	13	13	13	13	13

Clamping unit

Clamping force	kN	220	220	220	220	220	220	220
Distance between tie bars	mm (h x v)	254	254	254	254	254	254	254
Max. daylight between platen	mm	400	400	400	400	400	400	400
Max. opening stroke (adjustable)	mm	200	200	200	200	200	200	200
Min. mould height	mm	200	200	200	200	200	200	200
Max. mould weight on moveable clamping side	kg	150	150	150	150	150	150	150
Mould opening force	kN	40	40	40	40	40	40	40
Mould closing force	kN	17.6	17.6	17.6	17.6	17.6	17.6	17.6
Ejector stroke (max.)	mm	80	80	80	80	80	80	80
Ejector force pushing / pulling	kN	18.1 / 12	18.1 / 12	18.1 / 12	18.1 / 12	18.1 / 12	18.1 / 12	18.1 / 12

General

Installed driving power / total power	kW	5.5 / 7.7	5.5 / 8.1	5.5 / 8.8	5.5 / 9.1	5.5 / 11.3	5.5 / 11.3	5.5 / 11.3
Duration of the dry cycle (EUROMAP 6)	s – mm	1.6 – 178	1.6 – 178	1.6 – 178	1.6 – 178	1.6 – 178	1.6 – 178	1.6 – 178
Hydraulic system pressure	bar	160	160	160	160	160	160	160
Oil tank capacity	litre	115	115	115	115	115	115	115

Dimensiones and weights

BOY 22 A PRO

Dimensions (LxWxH) / Footprint	mm / m ²	2412 x 769 x 1689 / 1.85						
Total weight net (without oil)	kg	770						
Total weight gross (pallet & foil / wooden case)	kg	830 / 990						
Transport dimensions / case (LxWxH) approx.	m	2.3 x 1.06 x 2.2 / 2.3 x 0.96 x 1.6						

1) more injection units see Technical Data and Equipment

2) hydraulic motor with stroke volume 100 cm³ / 130 bar

3) hydraulic motor with stroke volume 160 cm³ / 130 bar

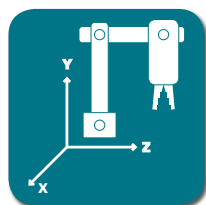

Automation



Made in Germany



Procan ALPHA 2®

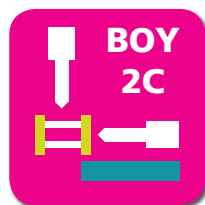

Multi Component

Equipment

Injection unit

Pivoting injection unit	-
Preset screw speed values with ramping transition	■
Cold start protection	■
Number of set points of injection speed	8
Number of set points of injection pressure	2
Start of holding pressure dependent on hydraulic pressure, stroke and time	■
Start of holding pressure, cavity pressure-dependent	□
Number of set points of holding pressure	8
Production monitoring at start of holding pressure	■
Closed loop control for the complete injection profile and back pressure	■
Control for intrusion-injection	■
PID microprocessor-controlled heating zones for cylinder + nozzle set and temp. display	5
Hydraulically actuated needle shut-off nozzle (pneumatic for XS-LSR)	○
Slide-away for quick material change (25 / 35 / 55 VV / 35 HV / 2C M / L without hopper)	○
Automatic material loader / feeder	□
Adjustable nozzle force	■
Delayed nozzle retraction	■
Servo-electric screw drive (separate feed line required)	-
High wear-resistant plasticizing units	○
High wear-resistant EconPlast unit	-
Speed injection	-

Clamping unit

Reduced mould height by 50 mm	□
Moving platen support to improve the precision when using large moulds	-
Number of set points of mould closing speed / opening speed	8/8
Number of reopening attempts after mould closing	■
Hydr. ejector with dig. adjustable pressure, speed, position + no. of strokes, intermediate stop position	■
Hydraulic ejector with adjustable stroke 80 mm	■
Hydraulic ejector with adjustable stroke 130 mm	-
Hydraulic ejector with adjustable stroke 150 mm and 42,7 kN force	-
Hydraulic unscrewing device, one or two directions of rotation with intermediate stop	-
Hydraulic unscrewing device, two directions, proportional valve and pulse generator	-
Core pull control with 4/3 way directional control valve and freely selectable operational programmes	□
Injection compression (coining) and breathing with mould degassing control	□
Hydraulic guard safety device	■
Self adjusting mechanical drop bar safety system with electronic monitor	□
Safety gate for handling devices	○
Electronically operated safety gate	-
Selection flap	○
Air ejection	□
Mould lifting crane	-
Simultaneous ejector movement (with double pump)	-
Integrated sprue picker	-

Electronics

USB interface for access and data exchange	■
Interface kit: Serial/Temperature device, USB/Printer and Ethernet	□
OPC interface	-
4 freely programmable inputs/outputs	□
Piece counter	■
Preselect cycle counter with auto shut-off	■
Grounded socket outlet 230 V ~ / 10 A (alternatively can be switched off)	■(□)
CEE socket outlet 400 V ~ / 16 A (alternatively can be switched off)	□(□)
Socket distributor 400 V ~ / 230 V ~ switched (separate feed line required)	□
Energy distributor with four fixed connections, up to 5 x 400 V CEE + 3 x 230 V (sockets can be switched off optionally). Standard supply 125 A / 5 x 50 mm²	-
Switch cabinet ventilation	■
Standardized interface for handling units (EUROMAP 12)	□
Separate feeder (heating and motor current)	○
7-day timer	■
Additional temperature control	□
Brush control	□
Connector for safety switch to inhibit mould closing	□
Integrated hot runner control, 8/16-fold (separate feed line required)	□
Air conditioning unit for control cabinet	□
Alarm signal with sound	□

Hydraulics

Electronically controlled variable pump	■
Servo-motor pump drive (Servo-drive)	-
Oil preheating circuit automatic	■
Oil temperature gauge / Controlled oil cooling / Oil level indicator	■
Oil level and temperature monitoring	■
Optical oil filter contamination indicator	-
Proportional action valve for the clamping unit	-
Proportional valve with stroke feedback and positioning action for clamp unit	-

General

4- / 6-zone cooling water distributor with electric shut-off valve for injection mould	○
Temperature control for feed throat	□
6- / 8-zone water distributor	○
Tool kit	□
Spare parts package	□
Oil filling	□
Anti-vibration mounts	■

■ standard ○ alternatively □ optional - not available

You would like to learn more about this BOY injection moulding machine?



Data and Equipment (complete overview)



Competence brochure



Dr. Boy GmbH & Co. KG

Industriegebiet Neustadt / Wied
Neschener Str. 6
53577 Neustadt-Ferndal
Germany

Phone: +49 (0)2683 307-0
Fax: +49 (0)2683 307-4555
E-Mail: info@dr-boy.de
Internet: www.dr-boy.de



BOY-APP
free of charge at
http://app.dr-boy.de

