

FALCON 400

Micro Hardness Tester | Vickers, Knoop, Brinell

MANUAL / SEMI - FULLY AUTOMATED



FALCON 400

Traditional technology reinvented...

The FALCON 400 improves on the conventional hardness testing methods by focusing on elimination of user influence on the test results. The advanced force sensor technology utilizes an electronically controlled loadcell closed loop system with force feedback to achieve absolute accuracy, reliability and repeatability, on all of the forces used for a testing.

The innovative software functions of I-Touch™ workflow control, allows file storage, test program setting and storing, limit settings, conversions to other hardness scales, system setup and convex and concave sample test settings that contribute to the exceptional repeatability and reproducibility of test results.



A FORCE RANGE, THAT SETS NEW STANDARDS!

1gf	5gf	2kgf	FALCON 401	31.25kgf
1gf		2kgf	FALCON 402	31.25kgf
1gf	10gf	10kgf	FALCON 403	31.25kgf
1gf		10kgf	FALCON 404	31.25kgf
1gf	10gf		FALCON 407	31.25kgf
1gf			FALCON 408	31.25kgf

HARDNESS SCALES



VICKERS 1gf - 31.25kgf*



KNOOP 1gf - 5kgf*



BRINELL 1 kgf - 31.25kgf*

* All scales

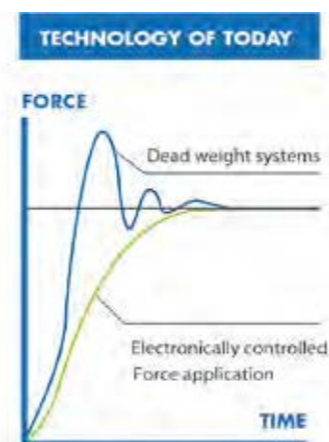

Load cell, closed loop, force feedback system

HIGHLIGHTS

- 1 Multi Load Cell, Closed Loop force application system, error <0.5%
- 2 6-position collision protected turret, 2 indenter positions; 4 LWD objectives positions
- 3 Analogue or electronic digital eyepiece - view via eyepiece and camera simultaneously
- 4 Full color industrial 6.5" touch screen interface with I-Touch firmware
- 5 Powerful embedded electronic system
- 6 5 Mega pixels, Full HD+, integrated TTL camera system (optional)
IMPRESSIONS XT indent evaluation and machine automation software,
- 7 4 different packages (optional)
- 8 Large CNC XY-stage (optional)
- 9 Top-class replaceable body parts, shock proof ABS covers

ADVANCED INNOVATION



Multi loadcell,
ball bearing,
force actuator

Z-Axis precision
movement

Unique machine structure

Rigidity and perpendicular indenter positioning are crucial to obtain Vickers indents with a perfect geometry. With a workpiece accommodation of 150 mm x 170 mm the FALCON 400 can be routinely used to conduct common advanced testing tasks.

Above the current...

1 6 POSITION PRECISION TURRET

The 6 position turret is supplied as a standard feature on all 400 models and allows to install indenters for Vickers, Knoop and Brinell (balls 1mm & 2,5mm) testing. The precision mechanics of the motorized turret permit super-fast and quiet positioning. Switching between indenter and objective is part of the automated test cycle. The turret offers up to 6 positions, with maximum 2 indenters, and 4 objective positions allowing you to fit all the magnification power for your application.

2 ANALOGUE OR DIGITAL EYEPIECE AND BUILT-IN CAMERA

The FALCON 400 can be equipped with a digital eyepiece which can be replaced easily by an analogue eyepiece for educational purposes. An installation of both eyepieces is also possible.

Camera for On SCREEN measurements in combination with the optional IMPRESSIONS™ software system. By accommodating the camera inside the head cover, it is protected against dirt and accidental damage or misalignment.

3 COLLISION DETECTION

To avoid any collision between the work piece and the turret, the turret has an overload protection. So neither the tester nor the workpiece are exposed to any damage.

4 MANUAL AND MOTORIZED XY-STAGES

The FALCON 400 is equipped with an adjustable manual stage that can carry up to 60kg or 100kg load, perfectly fitted for quick and easy single test. Optionally the FALCON allows to expand to a wide choice of motorized XY-stages. The IMPRESSIONS™ tester control and workflow software has many advanced positioning functions, from single indent to advanced pattern testing. The onboard controller allows up to 3 axis CNC work piece positioning.

5 6.5" FULL COLOUR HD TOUCH SCREEN, I-TOUCH

All machine control and process workflow can easily be operated from the 6.5" full-color HD touch screen. Mounted on a table stand, the display with smart Graphical User Interface (GUI), flexible in use, can be located either on the right or left of the machine for right or left handed operators. Due to its tilt function the display can be set up in such a way that either in standing or sitting position, the viewing and operating angle is always ideal.



6 SHOCK RESISTANT ABS MACHINE COVERS

A rock solid frame structure, that can withstand the harshest environment, is covered by shock and damage proof ABS covers. The covers avoid damage to the machines high tech interior and stay in a good condition over the years to come. No dents or paint damage from fallen work pieces. Replacement of the covers, if required at all, is easy and economic.

Innovative software functions

The I-Touch™ software provides clever multi-function keys for testing, set-up, storing and uploading of test programs, statistic control and more, making tester operation as easy as it can be. Data export, single or batch readings, with a single press on a button, or just fully automatic after measurement can be stored on a USB stick or transfer by cable to a PC to be imported or evaluated in EXCEL.

Further advanced features include extended statistics, shape correction for convex, concave or ball shaped specimens, hardness conversion to Rockwell, Brinell or Tensile strength according to ASTM E140 and ISO 18625 with different material tables.

There is a table top panel with a adjustable viewing angle or an integrated version imbedded in the testers frame. In all cases, the panel is mounted in a solid robust aluminum frame.



OPERATING COMFORT WITH I-TOUCH

INNOVATIVE SOFTWARE FUNCTIONS

1 OUT OF SET LIMITS



2 UNMISTAKEN TURRET POSITION



3 MEASUREMENT OVERVIEW



4 EXPORT FUNCTIONS





AUTOMATIC IMAGE

EVALUATION

1

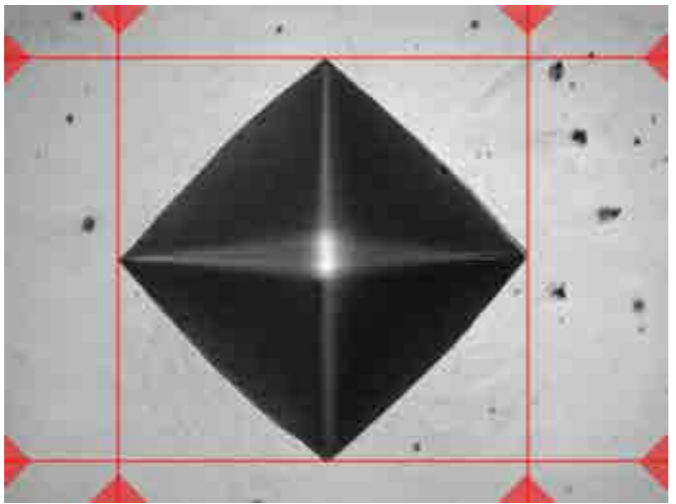

1 AUTOMATIC MEASUREMENT

Manual positioning of filar lines is no longer required. IMPRESSIONS™ refined measurement algorithms detect indents even on very poor or scratched surfaces and measure the relevant indent dimensions according to standards. Stay in control by switching to manual measure mode and have the option of adjusting measurements by touching the screen or using the mouse. Filar lines can be colored to give the best contrast against the specimen's surface. To assure that measurements meet relevant standards on symmetry, enable the automatic indent check. All hardness values can be converted to other scales according to ISO 18265, ISO 50150, ASTM E140.

**Evaluate whatever you want, --
because what gets measured, gets produced...**

2 ILLUMINATION SETTINGS

IMPRESSIONS™ software automatic illumination system adapts to the correct illumination regardless of the sample surface quality, wherever on the sample, independent from material (steel, carbide, coated or ceramic). Contrast, Brightness and program, can be set automatically for each measurement or controlled manually. Sharpness can be stored with the pre-determined test.

Too bright

OK

Too dark

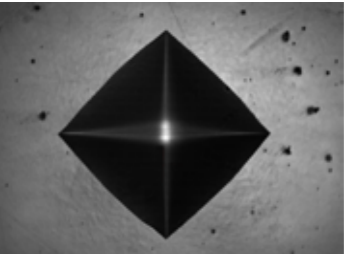
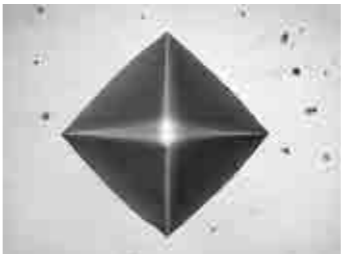
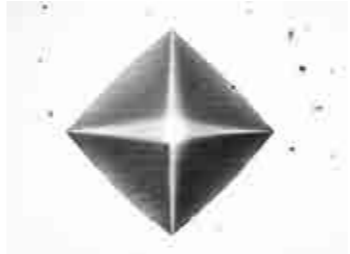

3

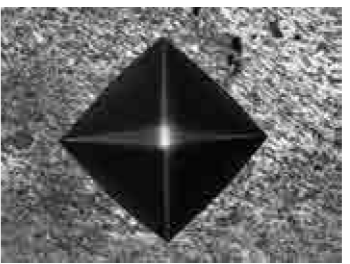
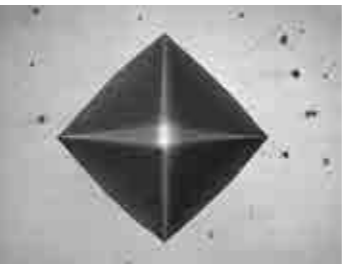

4

Irregular surface

Regular surface

Poor surface

3 REFINED IMAGE DETECTION

Complex, refined algorithms ensure reproducible measurements on different materials and even on scratched and damaged surfaces.

AUTOMATIC INDENT

EVALUATION

Indent evaluation software, also referred to as “tester automation”, often comes with a high level of complexity, both in setup and in operation. Breaking these rules, IMPRESSIONS XT™ (optional) focuses on fast and simple operation, for a less experienced operator.

A very easy to learn, work flow process but with functionality expected by expert users. IMPRESSIONS™ is optimized for evaluating Macro-Vickers, Micro-Vickers, Knoop & Brinell indents according to ISO, ASTM and JIS standards.

SELECT YOUR INDENT EVALUATION PACKAGE:

1 STANDARD (IMP-PACK2)

“IMPRESSIONS™ Software for manual and automatic measurement of Vickers / Knoop & Brinell indents, indent zoom function, automatic illumination adjustment.

Package Includes:

*High performance system controller with USB, HDMI, RS-232, WLAN, LAN connectivity. Industrial DVI/HDMI capacitive touch screen, with wireless keyboard and mouse, 5 Mpx HD industrial CCD camera, cable set.

Software features: Full tester configuration & control system, automatic brightness & contrast setting, automatic measurement of Vickers, Knoop and Brinell indents, manual CHD, SHD, NHD testing procedure, Kic measurement, set up and storing of test programs, set up and storing of tester configuration, limits (go/no go), diagrams, advanced report generator with editor.

NO INSTALLATION, NO ADDITIONAL PC REQUIRED!”

2 ADVANCED (IMP-PACK3 & IMP-PACK4)

As STANDARD package but offers two options :

IMP-3 has one digital micrometre X-axis that transfers the position of the stage to IMPRESSIONS™, whereas IMP-4 has two digital micrometres that transfer the position of the stage to IMPRESSIONS™.

3 PREMIUM (IMP-PACK5)

As STANDARD package but offers:

XY-Motorized CNC stage, 237x188mm, 100x100mm travel, loads up to 100kg, repeatability 0,003mm, with mounting holes for stage accessories. 3-axis CNC stage controller.

Fully automatic CHD, SHD, NHD testing procedure, advanced test pattern editor, click and go.

(Optional: surface overview camera)

NO INSTALLATION, NO ADDITIONAL PC REQUIRED!”



INDENT EVALUATION SOFTWARE

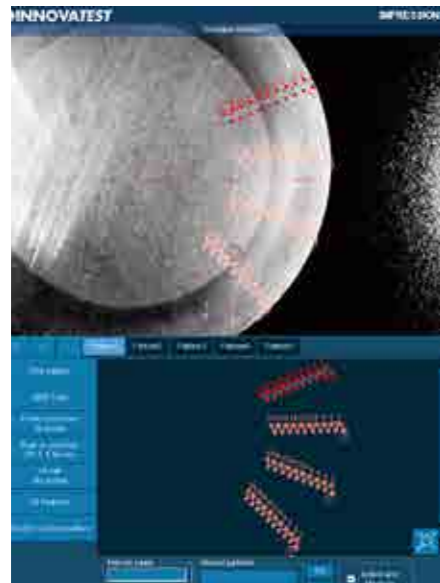

1 CHD, SHD, NHD

How do you increase throughput in your lab? Make the most common testing design as easy to set up as it is to perform automatically and still adhere to the applicable standards. CHD/SHD/NHD testing can be started directly from the surface view or from the overview. Additional core points of hardness can be defined separately for NHD measurements.

The distances of test points are automatically set to a minimum distance, following the standard, to assure correct testing is conducted. Time saving test mode “complete all indentations – then evaluate” and “auto-stop” to complete test series as soon as the lower hardness limit has been reached. Report Generator is enhanced with reporting features for this application.

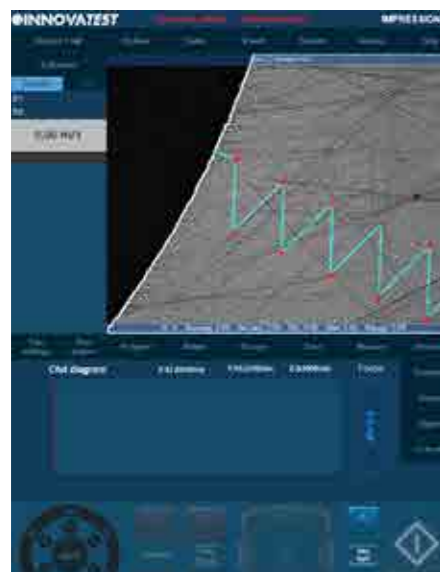

2 EDGE DETECTION

Technology that automatically or at a mouse click recognizes the edge of your sample. This helps to determine and fix the desired starting position for CHD or other pattern testing jobs.



3 AUTOMATIC CONTOUR SCANNING

This application scans the entire outline (or partial) area of a sample. The function can be used with an objective by using the overview zoom camera for high speed scanning. The system scans the entire outline defined and stores all relevant data in the test program.

Subsequently, a limitless number of test points can be inserted into the scanned image, or be set at selected distances (offset), relative to the edge. This advanced feature enables the hardness testing procedure to be performed automatically. An excellent feature to combine with 2D or 3D hardness mapping, also known as “plane hardness chart”.

4 SNAPSHOT FUNCTION

This handy function in IMPRESSIONS™ allows you to make screen captures of the viewing area by way of objective view and/or Overview camera. It gives the opportunity to store such images with comments or to paste them into the report generator for further processing.



5 PATTERN TESTING

The IMPRESSIONS™ pattern editor allows the user to create any number of test patterns with a large number of variable settings. Create test patterns with great precision and freedom. Verify the settings in the preview mode. Drag & drop patterns from one test sample to another sample. Live vision technique over zoom overview camera, no image stitching required.

Combine different patterns and even different test forces in one program, and run them fully automatically. All test points can be identified individually or to customer specifications. The label is shown in the test result list and in the test results overview and in the results print out. An important function for sample analyses at the end of a test and in the future for review of previous tests.

6 REPORT GENERATOR

Imagine having a report created for you that includes: Your company name, address, contact information, labeled results related to patterns or sequential, pictures of your optical measurements, stitched images, notes section for each result or pictures, rendition of the pattern performed, overview picture of your pattern on your sample, full statistics, summary of your results, go no-go results, Pass or fail... all that information or having the ability to only have what you need reported, we call this our Report Configurator. You decide how much or how little you report by PDF or laser printer. We even keep it simple by choosing export to CSV file, to a thumb drive or network file location. Data management at its best!

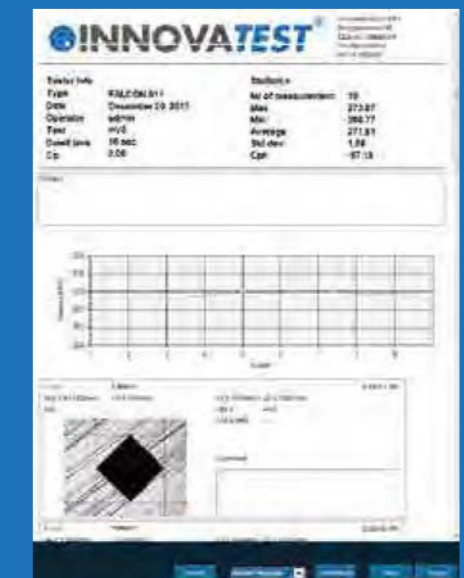

Yes, we can...



7 Kic CRACK MEASUREMENT

For those requiring more in depth knowledge on materials behavior, wishing to study material fracture and fatigue, crack growth can be predicted and measured by using the Kic application. The software supports Kic crack detection under load with customized Kic result reporting. By way of one or both methods, Palmqvist or Median / Radial, fracture toughness is now a repeatable and reproducible test across multiple operators.



8 USER DEFINED PROGRAMS

For repeating jobs, IMPRESSIONS™ utilizes the option of setting up and storing custom test programs. For each task, a "job" can be created. All application specific parameters, like hardness scale, force, dwell-time, pattern, conversion and the report template are stored in the same program.





LIMITLESS POSSIBILITIES

The FALCON 400 is routinely used for testing materials, components or parts in the aerospace and automotive industry, laboratories for sample evaluation or to conduct advanced testing tasks. The shock and damage proof covers protect are high-tech interior of this unique Micro-Macro Vickers machine.

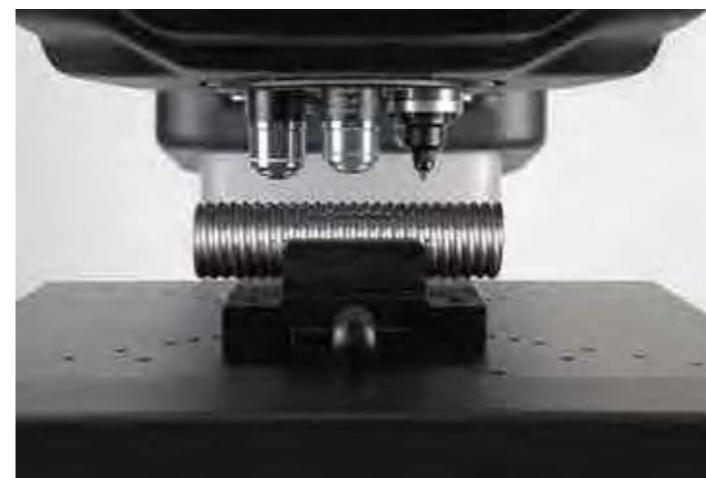
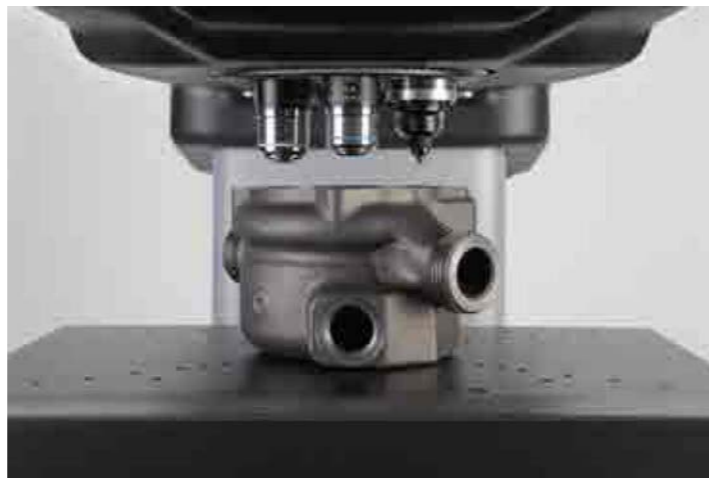
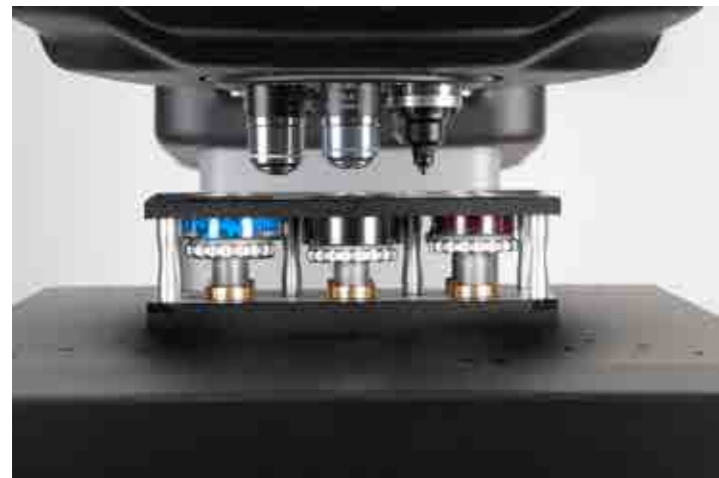

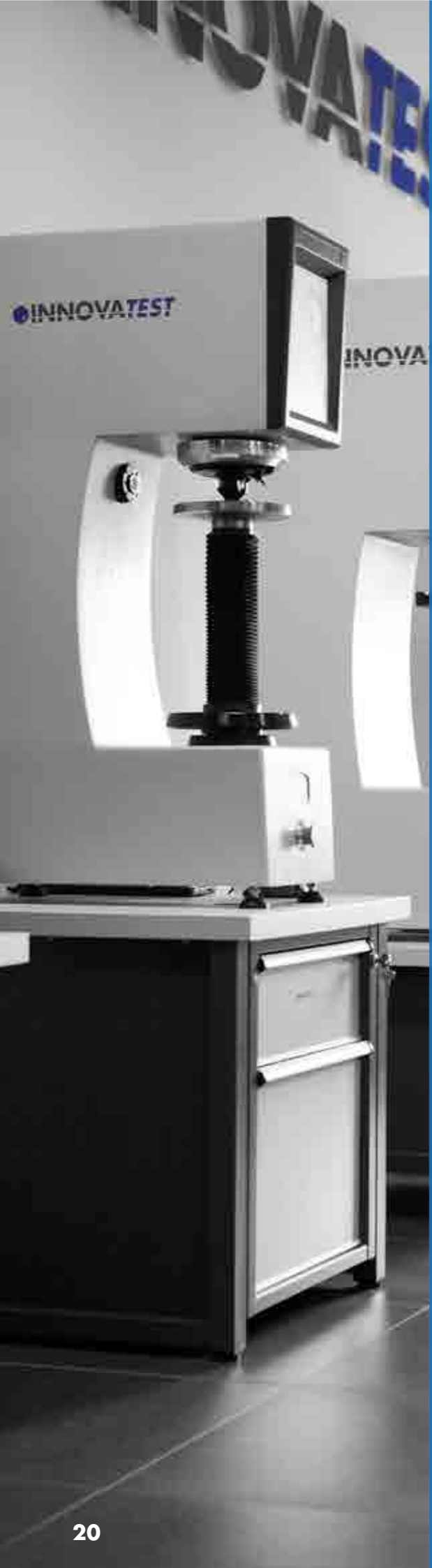

SUPPORT YOUR BEST TESTING RESULTS

With our rigid designed Bench stands

- Rock solid bench stands
- 100% retractable drawer, bearing guidance, max 100kg load. Rubber anti slip bottom
- Lockable cabinet, 300mm high
- Adjustable feet, (+/- 50mm height adjustable to reach ergonomic working position)
- Made of corrosion resistant zinc plated steel with RAL powder coating
- Carrying capacity of 400kg
- Top surface made of 50mm Plywood with 1.5mm chemical resistant plastic plating, edges made of shock resistant 3mm ABS side liner
- Industrial quality, for workshop or laboratory

Designed for hardness testing instruments, painted in INNOVATEST® RAL colors matching our testers.



UN-STAND/960 71 x 75 x 80 cm



UN-STAND/965 150 x 75 x 80 cm

ACCESSORIES FALCON 400

Schematic overview of the configuration options, standard and optional accessories

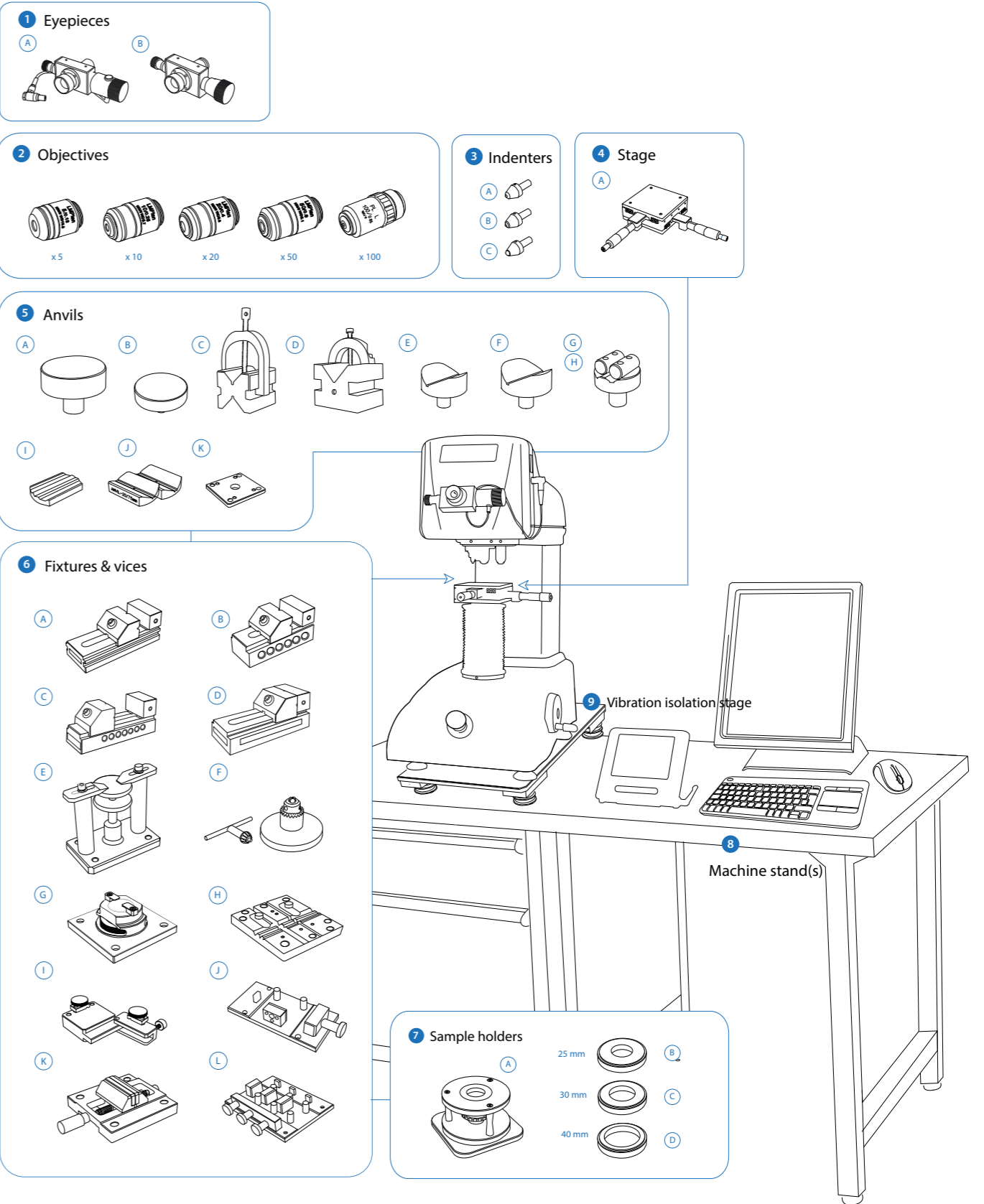

Not all accessories are displayed on this page. Full details can be found on the Order details page.

ORDER DETAILS

FALCON 400



FALCON 401 Micro hardness tester, 5gf - 2kgf	FALCON 401	
FALCON 402 Micro hardness tester, 1gf - 2kgf	FALCON 402	
FALCON 403 Micro hardness tester, 10gf - 10kgf	FALCON 403	
FALCON 404 Micro hardness tester, 1gf - 10kgf	FALCON 404	
FALCON 407 Micro hardness tester, 10gf - 31.25kgf	FALCON 407	
FALCON 408 Micro hardness tester, 1gf - 31.25kgf	FALCON 408	
Indenter actuator post (2nd indenter position) factory installed	FALCON/IP2	
Plug & Play prepared, calibration, sea & airworthy packing in "non coniferous wood" material	P&PSEAPACK10	

ACCESSORIES

1	Eyepieces	A	Electronic digital eyepiece with 15x magnification	AS-EYEPIECE/03	
		B	Analogue eyepiece with 15x magnification	AS-EYEPIECE/04	
2	Objectives		5x Long Working Distance (LWD) objective	BM-05-0001	
			10x Long Working Distance (LWD) objective	BM-05-0002	STANDARD
			20x Long Working Distance (LWD) objective	BM-05-0003	
			50x Long Working Distance (LWD) objective	BM-05-0004	STANDARD
			100x Long Working Distance (LWD) objective	BM-05-0005	
3	Indenters	A	Brinell Indenter 1mm. Includes 1 carbide ball. Ø3mm. ISO & ASTM certified	IN/7001	
			Brinell Indenter 2.5mm. Includes 1 carbide ball. Ø3mm. ISO & ASTM certified	IN/7006	
			Brinell Indenter 5mm. Includes 1 carbide ball. Ø3mm. ISO & ASTM certified	IN/7011	
		B	Micro Vickers Indenter Ø3mm ISO/ASTM certified	IN/8105	
		C	Micro Knoop Indenter Ø3mm ISO/ASTM certified	IN/8205	
		A	Manual X-Y stage with analogue metric micrometers, 100x100mm Displacement: 25x25mm, scale 0.01mm, max load 60kg	UN-XYSTAGE/115	STANDARD 401, 402, 403 & 404
4	Stage		Manual X-Y stage with analogue metric micrometers, 100x100mm Displacement: 25x25mm, scale 0.01mm, max load 100kg	UN-XYSTAGE/120	STANDARD 407, 408
			Fixing bush with flat mounting surface	CM-08-0003	STANDARD
			Digital micro meter, fits to manual X-Y stage. Displacement: 25mm, resolution 0.001mm	IMP-DIGMIC	
			Cable sets, mounting & connectivity for motorized stage		
			Lock flange	UN-XYZ BUSH40	
			Mounting plate for lock flange	UN-XYZ30FP40-42	
			3-axis embedded stage driver unit with internal cables/connector set, INCLUDED IN IMP SETS	IMP-XTDRIVER	
5	Anvils	A	Flat anvil 60mm	AS3000-19-04	
		B	Flat anvil 80mm	UN-TESTTABLE/002	
		C	V block with bracket 40x40x50mm (LxBxH)	UN-VBLOCK404050	

		D	Steel, cross type, (X) V-block 60x120x100mm 8-90mm pair	UN-CROSSBLOCK01	
		E	V-anvil ø40mm 6-60mm	UN-ANVIL/005	
		F	V-anvil ø63mm 10-100mm	UN-ANVIL/006	
		G	Cylindrical V anvil 6-80mm	UN-CVANVIL680	
		H	Cylindrical V anvil 50-200mm	UN-CVANVIL50200	
			Test table 100x100mm, V groove 20mm wide, 10mm deep	UN-TESTTABLE/040	
		I	Small V-Anvil 3-20mm requires base plate (Requires Manual/Autom. X-Y stage)	UN-ANVILSV/105	
		J	Large V-Anvil 20-75mm requires base plate (Requires Manual/Autom. X-Y stage)	UN-ANVILLV/106	
		K	Base plate for V-anvils un-anvilsv/105 & 106	UN-VANVILBASEPL	
6	Fixtures & vices	A	Polished precision vice with lock down system, jaw width 25mm, opens 20mm	UN-VICE/210	
		B	Polished precision vice with lock down system, jaw width 36mm, opens 42mm	UN-VICE/215	
		C	Polished precision vice with lock down system, jaw width 48mm, opens 75mm	UN-VICE/220	
		D	Polished precision vice with lock down system, jaw width 75mm, opens 100mm	UN-VICE/230	
		E	Axle chuck 500 series for cylinder parts, dia. 0.4mm to 5mm	UN-AXLECHUCK	
		F	Universal Clamp & Leveling Device	UN-CLAMP/105	
		G	Thin metal clamp	UN-CLAMP/115	
		H	V groove clamp for small round parts dia.0.8-5mm	UN-VGROOVE- CLAMP	
		I	Wire Testing Fixture	UN-WIRE/105	
		J	JOMINY Fixture, for 1 quench end test sample, quick release function	UN-JOMFIX1	
		K	JOMINY Fixture, for 3 quench end test sample, quick release function	UN-JOMFIX3	
	L	Small parts vice jaw width 55mm, open 50mm, self centering	UN-VICE/115		
7	Sample holders	A	1 position sample holder, for 1 embedded sample, diameter 50mm or 2"	UN-ESH1	
		B	1 insert reduction ring 25mm	UN-ESHI25	
		C	1 insert reduction ring 30mm	UN-ESHI30	
		D	1 insert reduction ring 40mm	UN-ESHI40	
			1 insert reduction ring 1"	UN-ESHI1	
			1 insert reduction ring 1 1/4"	UN-ESHI125	
			1 insert reduction ring 1,5"	UN-ESHI15	

8	Machine stands	A	Cabinet test table with drawer for hardness testers 71x75x80cm	UN-STAND/960
		B	Cabinet test table with drawer for hardness testers 150x75x80cm	UN-STAND/965
			Seaworthy packing box for 950/960	PACK/100
			Seaworthy packing box for 965	PACK/200
9	Vibration isolation stage		Passive vibration isolation stage, broad spectrum	UN-AVS-150
		Printer	Laser Printer	UN-PRINT
	Machine cover	Anti Static machine cover 453x690x945mm	UN-TESTERCOVER06	
	ISO / ASTM verification	BRINELL direct and indirect verification/calibration & certification in compliance with ISO & ASTM, NADCAP. Includes direct force and indirect verification report (block readings), GR & R report, flat fee for selected common scales, per scale.	CALCEFRDW/1B	
		VICKERS direct and indirect verification/calibration & certification in compliance with ISO & ASTM, NADCAP. Includes direct force and indirect verification report (block readings), GR & R report, flat fee for selected common scales, per scale.	CALCEFRDW/1V	
	KNOOP direct and indirect verification/calibration & certification in compliance with ISO & ASTM, NADCAP. Includes direct force and indirect verification report (block readings), GR & R report, flat fee for selected common scales, per scale.	CALCEFRDW/1K		

ACCESSORIES

EYE PIECES



AS-EYEPIECE/03



AS-EYEPIECE/04

OBJECTIVES



5x Long Working Distance objective



50x Long Working Distance objective



10x Long Working Distance objective



100x Long Working Distance objective



20x Long Working Distance objective

INDENTERS

A



1mm Carbide Ball Indenter Ø3mm



5mm Carbide Ball Indenter Ø3mm

C



Micro Knoop Indenter Ø3mm

B



2.5mm Carbide Ball Indenter Ø3mm

B



Micro Vickers Indenter Ø3mm

STAGE

A



UN-XYSTAGE/115
UN-XYSTAGE/120

ANVILS

A



AS3000-19-04

B



UN-TESTTABLE/002

C



UN-VBLOCK404050

D



UN-CROSSBLOCK01

E



UN-ANVIL/005

F



UN-ANVIL/006

G



UN-CVANVIL680
UN-CVANVIL50200

I



UN-ANVILSV/105

J



UN-ANVILSV/106

K

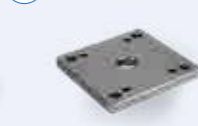

UN-VANVILBASEPL

ORDER DETAILS

FIXTURES AND VICES



SAMPLE HOLDERS



MACHINE STANDS



VIBRATION ISOLATION STAGE



SOFTWARE PACKS

GUI: Full tester & configuration control, 3 simultaneous conversions to other hardness scales, limit settings, color indication for measuring results, results list with highlighted in and out of limit values, graphics engine to display turret positions and indenter positions, test force progress bar.		
Full tester configuration & control system, automatic brightness & contrast setting, automatic measurement of Vickers, Knoop and Brinell indents, manual CHD, SHD, NHD testing procedure, Kic measurement, set up and storing of test programs, set up and storing of tester configuration, limits (go/no go), diagrams, advanced report generator with editor. NO INSTALLATION, NO ADDITIONAL PC REQUIRED!	400/IMP-PACK2	
Full tester configuration & control system, automatic brightness & contrast setting, automatic measurement of Vickers, Knoop and Brinell indents, manual CHD, SHD, NHD testing procedure, Kic measurement, set up and storing of test programs, set up and storing of tester configuration, limits (go/no go), diagrams, advanced report generator with editor. NO INSTALLATION, NO ADDITIONAL PC REQUIRED!	400/IMP-PACK3	
Full tester configuration & control system, automatic brightness & contrast setting, automatic measurement of Vickers, Knoop and Brinell indents, manual CHD, SHD, NHD testing procedure, Kic measurement, set up and storing of test programs, set up and storing of tester configuration, limits (go/no go), diagrams, advanced report generator with editor. NO INSTALLATION, NO ADDITIONAL PC REQUIRED!	400/IMP-PACK4	
Full tester configuration & control system, automatic brightness & contrast setting, automatic measurement of Vickers, Knoop and Brinell indents, Kic measurement, set up and storing of test programs, set up and storing of tester configuration, limits (go/no go), diagrams, advanced report generator with editor. XY-Motorized CNC stage, 237x188mm, 100x100mm travel, loads up to 100kg, repeatability 0,003mm, with mounting holes for stage accessories. 3-axis CNC stage controller. Fully automatic CHD, SHD, NHD testing procedure, advanced test pattern editor, click and go. (Optional: surface overview camera) NO INSTALLATION, NO ADDITIONAL PC REQUIRED!	400/IMP-PACK5	

SOFTWARE

Additional Software	Advanced 3 axis coordinate & free style indent pattern configurator, for motorized stage only	UN-TESTPAT01	* IMP-PACK 5
	Advanced 3 axis coordinate & free style indent pattern configurator, + CHD, SHD, NHD and edge detection, (supports manual & digital micrometer stages only)	UN-TESTPAT02	* IMP-PACK 2,3,4
	Kic crack detection under load. Palmqvist & Median / Radial fracture toughness	UN-CRKPAP	* IMP-PACK 2,3,4,5
	Automatic Contour scanning	UN-CSCAN	* IMP-PACK 5
	Drawing and measuring (distance & angles) application	UN-DRMEAS	
	Automatic edge detection	UN-EDGEDTC	* IMP-PACK 5
	ISO-2702 tap screw thread measurement	UN-ISO2702	* IMP-PACK 5
	User level management	UN-LEVMAN	STANDARD
	CHD, SHD, NHD configurator & graphic interface for analogue and digital micro meter stage only (not including full pattern editor)	UN-MCHD	* IMP-PACK 2,3,4
	CHD, SHD, NHD configurator & graphic interface requires: indent pattern configurator (TESTPAT01)	UN-PATCHD	* IMP-PACK 5
	Q-DAS Certified connectivity protocol	UN-QDAS	
Connectivity Plus	Blue Tooth connectivity	UN-BTADAPT	
	Wireless system Keyboard & wireless mouse	UN-SKBSET	

* Available for :

SPECIFICATIONS

HARDNESS SCALES

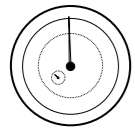
	VICKERS ISO 6507 ASTM E384, E92 JIS B 7725	HV0.001 HV0.002 HV0.003 HV0.004 HV0.005 HV0.006 HV0.007 HV0.008 HV0.009 HV0.010 HV0.015 HV0.020 HV0.025 HV0.050 HV0.1 HV0.2 HV0.3 HV0.5 HV1 HV2 HV2.5 HV3 HV4 HV5 HV10 HV20 HV25 HV30
	K1c Fracture toughness	KC/1 KC/3 KC/5 KC/10 KC/15 KC/20 KC/25 KC/50 KC/100 KC/200 KC/300 KC/400
	KNOOP ISO 4545 ASTM E92 JIS Z 2251	HK0.001 HK0.003 HK0.005 HK0.01 HK0.015 HK0.02 HK0.025 HK0.05 HK0.1 HK0.2 HK0.3 HK0.5 HK1 HK2 HK5
	BRINELL ISO 6506, ASTM E10 JIS Z 2243	HBW1/1kgf HBW1/1.25kgf HBW1/2.5kgf HBW1/5kgf HBW1/10kgf HBW1/30kgf HBW2.5/6.25kgf HBW2.5/7.8125kgf HBW2.5/15.625kgf HBW2.5/31.25kgf HBW5/25kgf HBW5/31.25kgf
	CONVERSIONS	Conversion to other hardness scales according to ASTM E140, ISO 18265, GB/T 1172

TEST FORCE

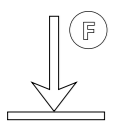
	Force application	Multi-load cell, closed loop, force feedback system
	Test forces	1gf – 31.25kgf
	Force range per model	FALCON 401 5gf – 2kgf FALCON 402 1gf - 2kgf FALCON 403 10gf - 10kgf FALCON 404 1gf - 10kgf FALCON 407 10gf - 31.25kgf FALCON 408 1gf - 31.25kgf
	Test force tolerance	< 0.5% for all test forces
	Dwell time settings	Default 10 seconds, user defined.

TURRET

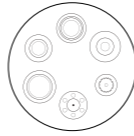
	Motorized turret	Ultra-fast, 6 position turret, 2 indenter positions, 4 objective positions
	Objectives	Long working distance 5x, 10x, 20x, 50x, 100x
	Indenters	Certified indenters (ISO/ASTM) available at choice
	Eyepiece	Analogue eyepiece with 15x magnification Electronic digital eyepiece with 15x magnification
	Camera	5 Mpx optical zoom system (optional)

SYSTEM

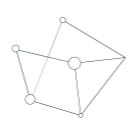
	Electronic system	High performance embedded electronics system running i-Touch firmware
	CNC support	CNC controller (for motorized stages) or stage accessories (IMP Pack 5)
	Screen(s)	6.5" display, 15" LCD screen (optional)
	Display resolution	0.1 HV, HK, 0.5 HB
	Statistics	Total test, max, min, average, range, standard deviation, All in real time after each test
	Hardness conversion	Rockwell, Rockwell Superficial, Vickers, Brinell, Knoop, Leeb & Tensile
	Software	i-Touch firmware, work flow system & tester control
	Data output	USB
	Connectivity	USB-2
	Printer	A4, A3 full color laser printer (optional)

GENERAL

	Machine dimension	525 mm x 323 mm x 688 mm
	Machine weight	75 kg
	Power supply	100VAC to 240VAC, 50/60Hz, single phase
	Operating temperature	10°C to 35°C, non-condensing
	Power consumption	75W
	Humidity	10% to 90%, non-condensing

TECHNICAL DRAWINGS

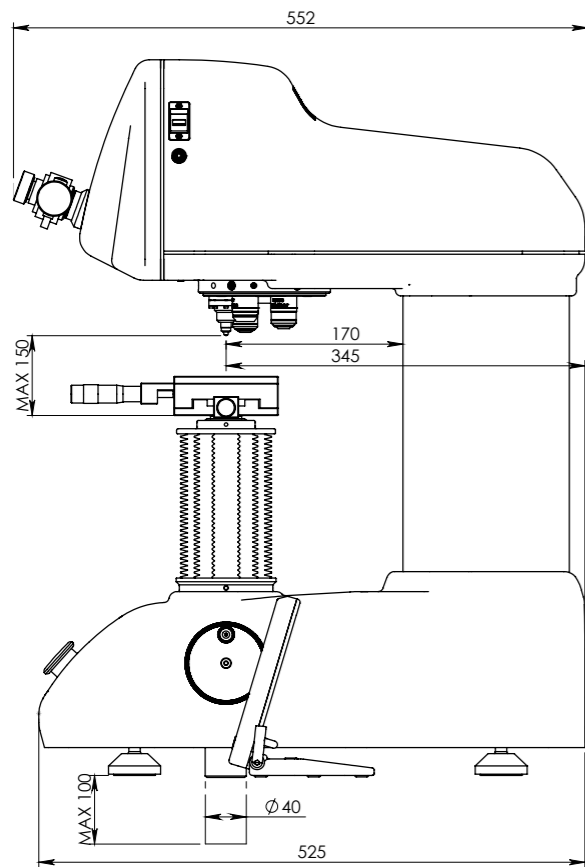

All dimensions in these drawings are in mm, approximate. Working heights and or workpiece accommodation varies depending on the stages and stage accessories used.

Please contact our sales department for more details.

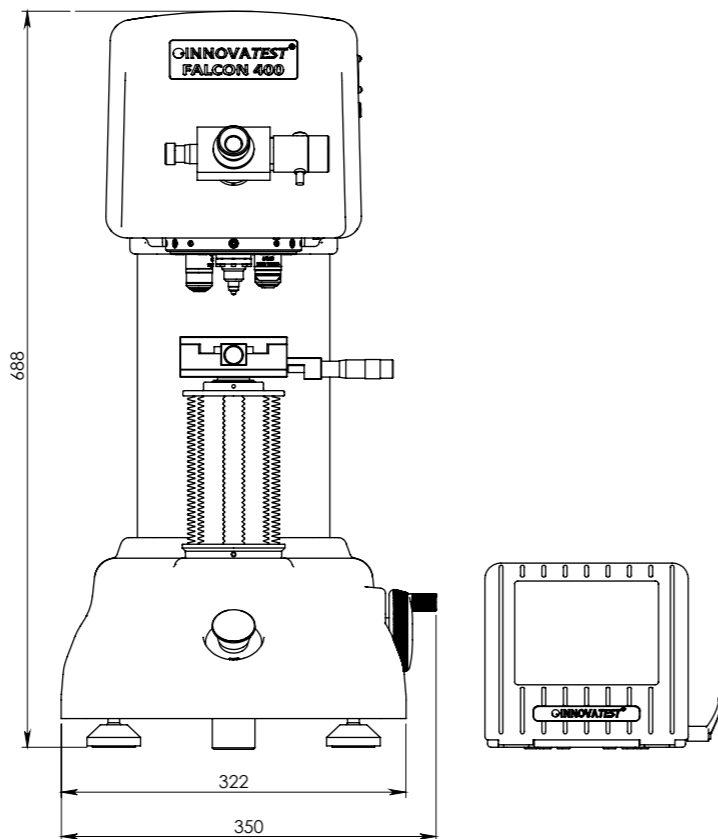

OTHER MODELS IN THE FALCON RANGE



FALCON 450

Load Cell, closed loop
Macro/Micro Vickers, Knoop & Brinell Hardness tester
With Z-axis handwheel
See brochure B18F450/XX



FALCON 500

Multi Load Cell, Closed loop
Fully automatic, free to configure
Micro/Macro Vickers, Knoop & Brinell Hardness testers. With ball bearing motorized Z-axis
See brochure B18F500/XX



FALCON 600

Multi Load Cell, Closed loop
Fully automatic, free to configure
Micro/Macro Vickers, Knoop & Brinell Hardness testers. With ball bearing motorized Z-axis
See brochure B18F600/XX



FALCON 5000

Multi Load Cell, Closed loop
Fully automatic, 8 position turret, laser positioning.
Micro/Macro Vickers, Knoop & Brinell Hardness testers.
Descending test head, fixed work piece position
See brochure B18F5000/XX



FALCON 5003XL

Multi Load Cell, Closed loop
Fully automatic, 8 position turret, laser positioning.
Micro/Macro Vickers, Knoop & Brinell Hardness testers
Descending test head, fixed work piece position
See brochure B18F5003XL/XX

Changes in products and/or product specifications can emerge due to new technologies and continuous development.

We reserve the right to change or modify specifications of the products without prior notice. We recommend you to contact our sales office for up-to-date information.

Brochure B19F400/07/EN

Distributor :

CORPORATE HEAD OFFICE

INNOVATEST Europe BV

Manufacturing, Distribution & Service

Borgharenweg 140
6222 AA MAASTRICHT
The Netherlands

Phone: +31 43 3520060

Fax: +31 43 3631168

info@innovatest-europe.com

www.innovatest-europe.com

INNOVATEST Deutschland GmbH Sales & Service

Phone: +49 245 670 59 500
info@innovatest-deutschland.com
www.innovatest-deutschland.com

INNOVATEST Polska sp. z.o.o Sales & Service

Phone: +48 697 099 826
info@innovatest-polska.pl
www.innovatest-polska.pl

INNOVATEST Shanghai Co., Ltd. Sales & Service

Phone: +86 21 60906200
info@innovatest-shanghai.com
www.innovatest-shanghai.com

INNOVATEST Japan Co., Ltd. Sales & Service

Phone: +81 3 3527 3092
info@innovatest-japan.com
www.innovatest-japan.com

INNOVATEST USA Company Sales & Service

Phone: +1 267 317 4300
info@innovatest-usa.com
www.innovatest-usa.com

INNOVATEST South East Asia Sales & Service

Phone: +65 6451 1123
info@innovatest-singapore.com
www.innovatest-singapore.com