

thermo scientific



Thermo Scientific
Neptune XT MC-ICP-MS

ThermoFisher
SCIENTIFIC

Neptune XT MC-ICP-MS

A new edition of the market leading Thermo Scientific™ Neptune™ Series MC-ICP-MS, capturing the best of technology for high-precision isotope ratio analysis.



Thermo Fisher Scientific: pioneering multicollector technologies,

- First with RPQ for abundance sensitivity.
- First to introduce a reliable moveable collector array, over 500 built.
- First to report ultra-high-precision static isotope ratio measurements.
- First for high-resolution MC-ICP-MS, enabling measurement of Si, S, Ca, Fe, Ni and many more isotopic systems.
- First with stable and linear SEM and then CDD ion counters.
- First for sensitivity – the Jet Interface offers the highest ICP-MS sensitivity available.
- First with $10^{13} \Omega$ Amplifier Technology, extending the benefits of Faraday cup detectors to smaller sample amounts.
- First with the XHR option – 15,000 MRP for hydride interference removal from ^{25}Mg , ^{29}Si , ^{37}Cl and ^{41}K .

All these firsts have been supported by continuous improvement of our instrumentation, with software that facilitates access to the latest technologies. The Neptune Series instruments are the established market leader for MC-ICP-MS, with an enviable reputation for producing robust scientific data. Every Neptune Series instrument is supported by a professional global organization that ensures long term, ongoing support. The result is a user base that has achieved exceptional scientific productivity.

... perfecting multicollector
technology for application.



Neptune XT MC-ICP-MS

Combining two decades of development

The Neptune XT is a double-focusing multicollector inductively-coupled plasma mass spectrometer (MC-ICP-MS), integrating the established field-proven technologies from the Neptune Series instruments, with the latest developments in technology for isotope ratio analysis from Thermo Fisher Scientific™. The Neptune XT MC-ICP-MS incorporates Thermo Scientific™ $10^{13} \Omega$ Amplifier Technology™ and the Jet Interface, so that users can extract the highest precision information from their samples. For the toughest analytical challenges the Neptune XT MC-ICP-MS can be configured with options for enhancing resolution (XHR), abundance sensitivity (RPQ) or with an ion counter array (SEM and CDD).

Every user benefits from the stability of the Neptune series instrumentation. Tuning is aided by the stability of tune parameters, so that less time and effort is spent tuning and more time is spent generating robust scientific data sets.

The fundamentals of the mass analyzer

The Neptune XT MC-ICP-MS separates ions generated by an inductively-coupled plasma through a double-focusing mass analyzer onto a variable multicollector detector array. The kinetic energy distribution of ions generated by an ICP ion source is wider than that from a thermal ionization source, and a double-focusing mass analyzer is the best technical solution for this problem. The result is an accurate separation of masses focused onto focal plane, along which ion detectors can be brought into precise alignment with the ion beams.



Jet Interface

Ultimate sensitivity, ultimate precision

The ultimate theoretical limit to precision for any isotope ratio measurement is from the counting statistics of the number of ions which are detected. In many applications this dictates the minimum sample amount from which useful information can be extracted. The Jet Interface, in combination with a desolvating nebulizer system, increases sensitivity by a factor of ca. 25. Sample ion yields of greater than 1.8 % are achieved for uranium, and it is well recognized as the most sensitive ICP-MS available. Sensitivity is matched by stability of mass bias, so the advantages of higher signal intensities are realized with higher precision isotope ratios. This major improvement in ICP-MS technology, where uranium ion transmissions of < 0.1 % are more typical, has led to a revolution, slashing sample amount requirements and increasing precision.

The outstanding performance of the Jet Interface is achieved with a high-performance interface pump, an optimized interface design, and a unique set of cones that address individual application needs. Accurate $^{143}\text{Nd}/^{144}\text{Nd}$ ratios are achieved with a high-sensitivity low-oxide cone combination (H and Jet), whilst $^{176}\text{Hf}/^{177}\text{Hf}$ measurements benefit from the highest sensitivity achieved using the X skimmer cone for example. The benefits also extend to laser ablation applications, where spatial resolution can be increased. Or the laser ablation split stream (LASS) technique can be used to obtain additional elemental or U-Pb information, without compromising the precision of the Lu-Hf or Sm-Nd measurement for example.

The water-cooled laminated magnet ensures the user can quickly switch between different applications, an essential capability in a multi-user laboratory. The Neptune XT MC-ICP-MS utilizes a 10 kV acceleration voltage, which maximizes transmission and minimizes mass discrimination through the mass analyzer. Combined with proven ion transfer optics and ICP technology, the Neptune XT MC-ICP-MS delivers exceptional accuracy, mass bias stability and sensitivity.

An interface at ground potential

The plasma interface of the Neptune XT MC-ICP-MS is held at ground potential, allowing safe access to the nebulizer, spray chamber and torch. Changing from solution mode to any coupled device is straightforward; for example to laser ablation, gas chromatography or HPLC. As such the Thermo Scientific™ GCI-300™ Interface for gas chromatography applications can be easily coupled to the Neptune XT MC-ICP-MS.

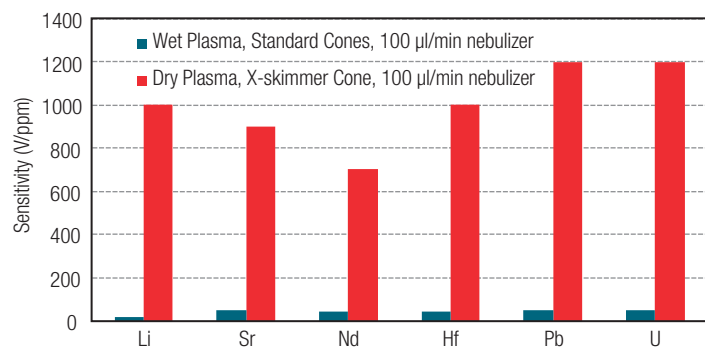

Sensitivity of the Neptune XT MC-ICP-MS, comparing Jet Interface with wet plasma. Note: sensitivity specifications are given for 100 µl/min uptake rate. A desolvating nebulizer system is required for the dry plasma specifications (optional item).

High Resolution MC-ICP-MS

The Neptune MC-ICP-MS introduced high mass-resolution to MC-ICP-MS, enabling new applications with high-precision interference-free isotope ratio measurements. Flat interference-free plateaus are ideal for MC-ICP-MS isotope ratio measurements and ensure the highest precision results.

The Neptune XT MC-ICP-MS can be operated at three different resolution settings: low, medium and high. A reproducible resolution setting can be conveniently selected through the software. The Neptune XT MC-ICP-MS is optimized for transmission, over 20% transmission can be retained for measurements of isotope systems such as Si, S and Fe.

In order to achieve the high mass resolution necessary to separate molecular interferences from elemental peaks a narrow source slit is selected. Through a combination of narrow source and wide detector slits, interferences can be separated from the analyte ions on either side of the detector slit. The majority of molecular interference are in the low and middle mass range, and according to the systematics of the nuclear mass defect, these interferences are typically heavier than the elemental species. A wide detector slit in all mass resolutions is the best choice, since it guarantees the widest peak flatness, which is essential for highly precise and accurate isotope ratio analyses.

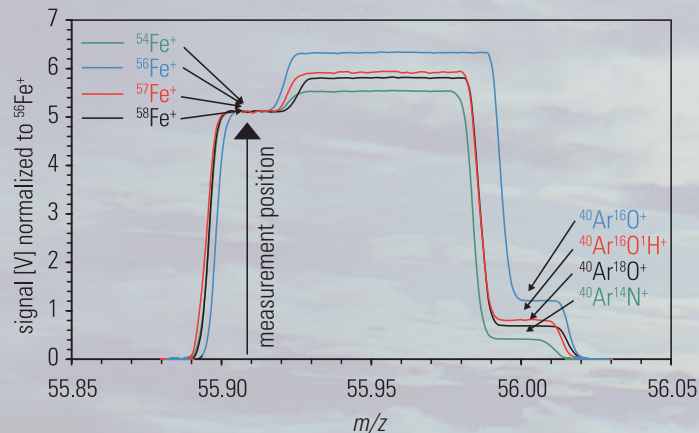
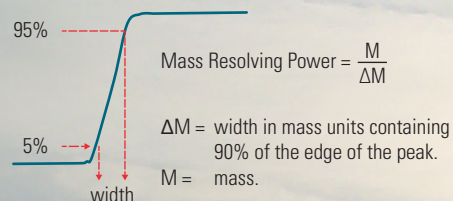

Low Resolution Mode



Interference + Analyte

High Resolution Mode

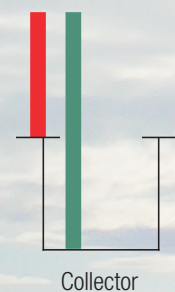

Interference / Analyte

Mass scan for iron isotopes (left), showing the measurement position for high-precision interference-free measurements of $\delta^{56}\text{Fe}$, $\delta^{57}\text{Fe}$ and $\delta^{58}\text{Fe}$ (Weyer & Schwieters 2003).

Schematic depiction of low resolution and high resolution measurement modes (middle and right) showing the separation of interference such as ArO^+ from the $^{56}\text{Fe}^+$ analyte ions.

XHR – Extra High Resolution

The new Thermo Scientific™ XHR™ Option for the Neptune XT MC-ICP-MS increases the resolving power to 15,000 by including a switchable intermediate aperture. By doing so it allows access to hydride interference removal from systems such as Si, Mg, Cl and K. This extraordinary increase in resolution was only possible through nearly 20 years of continual improvement of peak position stability that benefits all today's Neptune XT instruments.



CASE STUDY

$\delta^{41}\text{K}$ analysis by using XHR mode

The potassium isotopic system has applications in terrestrial geochemistry, planetary science, and potentially for biomedical and agricultural research. The strong $^{40}\text{Ar}^1\text{H}^+$ interference on ^{41}K has until recently limited its measurement by MC-ICP-MS. By increasing the resolving power of the Neptune XT MC-ICP-MS, the XHR option opens the door to precise, accurate and routine measurement of the potassium isotopic system by MC-ICP-MS.

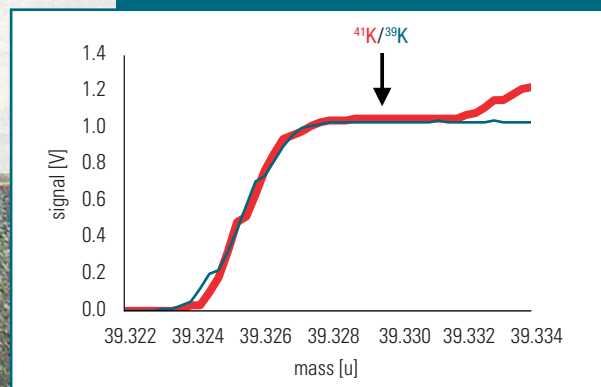
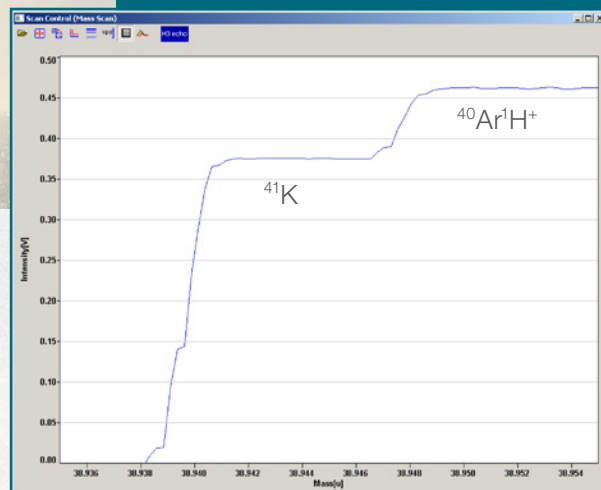

Mass scans on the $^{41}\text{K}^+$ peak using the new XHR Extra High Resolution Option for Neptune XT MC-ICP-MS.

$^{41}\text{K}^+$ is clearly resolved from the polyatomic interference $^{40}\text{Ar}^1\text{H}^+$.

The Detection System

Variable detector array

At the heart of the Neptune XT MC-ICP-MS is the variable multicollector detector array. A highly reliable mechanism that brings up to nine Faraday cups into precise alignment with ion beams of different dispersions. This ensures the flexibility to cover isotopic applications from Li through to U, in low or high resolution, and without compromising the native dispersion of the mass analyzer.

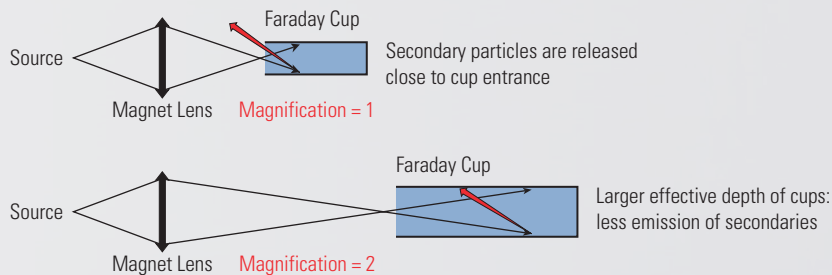

High-performance Faraday cups

The Faraday cups used in the Neptune XT MC-ICP-MS are the same as those used in Thermo Scientific™ Triton™ Series TIMS instruments, and are capable of making the highest precision static isotope ratio measurements. The combination of the 2x magnification of the mass analyzer, with wide and deep Faraday cups, means that ion beams are captured in their entirety. Precision machined from solid graphite for uniform response; cup factors are eliminated.

Flexibility of detector types

The Neptune XT MC-ICP-MS offers a highly flexible detector system, with three different detector types spanning more than 9 orders of magnitude in signal intensity range (from 1 cps to 3 Gcps). The central channel of the Neptune XT MC-ICP-MS is equipped with a dual mode detector that can be switched from Faraday cup to SEM ion counter, and with the proprietary relay matrix any amplifier can be assigned to any of the Faraday cups via software.

Multi ion counting arrays

The smallest sample amounts and the lowest abundance isotopes require the use of ion counting detectors. The Neptune XT MC-ICP-MS can be fitted with a Multi Ion Counting (MIC) array to allow simultaneous detection of the lowest intensity ion beams. Efficiency is significantly increased when compared with single collector measurements. Up to eight discrete dynode secondary electron multipliers can be installed on the Neptune XT MC-ICP-MS, with packages tailored for different applications (see page 11). The SEM and CDD ion counters available for the Neptune XT MC-ICP-MS offer excellent stability, linearity and lifetime characteristics.

CASE STUDY

Analysis of ^{234}U and ^{236}U in nuclear materials

Reliable measurement of $^{234}\text{U}/^{238}\text{U}$ and $^{236}\text{U}/^{238}\text{U}$ provides key information for nuclear safeguarding, but measurements can be challenged by the very low abundance of ^{234}U and ^{236}U . Ion counters offer the lowest quantification limits for these isotopes. Scattered ions (tailing), from ^{238}U and ^{235}U , can bias the measured ratios. The Retarding Potential Quadrupole (RPQ) improves abundance sensitivity by an order of magnitude, for accurate quantification of minor isotopes.

The Neptune XT MC-ICP-MS can be configured with two RPQ lenses for simultaneous ^{234}U and ^{236}U analysis. Nuclear MIC packages offer comprehensive coverage of U and Pu isotopic measurements, with flexibility to use combinations for ion counters and Faraday cups for isotopic sample amount from the fg to μg level. Combined with the Jet Interface, for ultimate sensitivity, fg isotopic amounts can be analyzed for precise information.

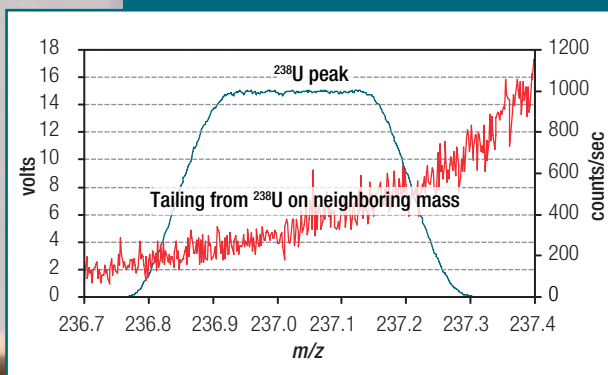

Peak tailing from ^{238}U onto m/z 237.05 (purple trace cps). The ^{238}U beam is shown for reference (Volt scale). Tailing at two masses is further reduced; especially applicable to the measurements of ^{236}U and ^{230}Th .

Neptune XT

A new edition of the market leading Neptune Series MC-ICP-MS, capturing the best of technology for high-precision isotope ratio analysis.

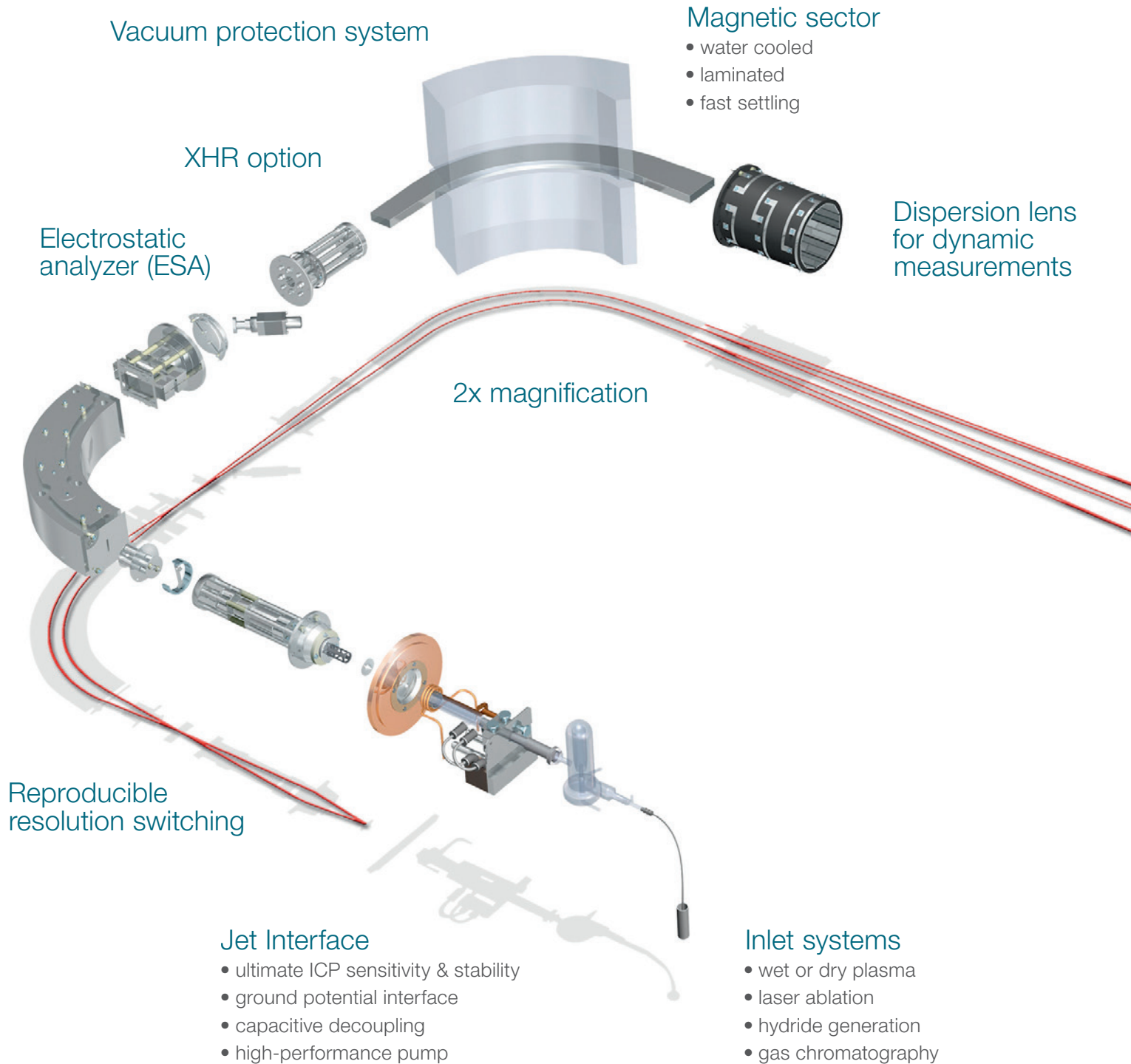

CASE STUDY

U-Pb ages from zircons and carbonates

For geoscience applications the Neptune XT MC-ICP-MS offers dedicated collector packages for the analysis of U-Pb from carbonates, or U-Pb and Lu-Hf or Sm-Nd from zircons and other accessory minerals. The dual detector (Faraday / SEM) for ^{206}Pb provides coverage for both old and young ages. The setup allows for quick switching between the U-Pb and Lu-Hf or Sm-Nd systems. The Neptune XT MC-ICP-MS delivers on both detection system and sensitivity, allowing more precise measurements to be made with higher spatial resolution than was previously accessible.

8 moveable Faraday cups 1 central dual-mode detector

- no cup factors
- precise positioning
- maximum flexibility
- highly reliable mechanism

RPQ (optional)

- ultra-low abundance sensitivity

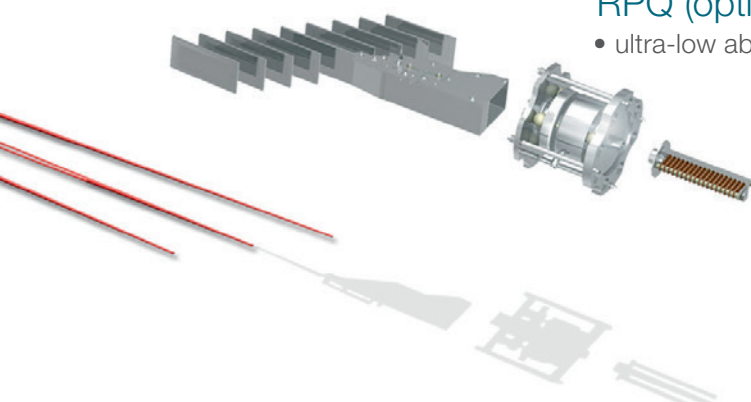

10 ion current amplifiers

- 50 V dynamic range
- freedom of amplifier selection
- $10^{13} \Omega$ Amplifier Technology
- high temperature stability

SEM

- high linearity
- high stability
- long lifetime

Ion counter arrays for nuclear safeguards.

CDD	SEM RPQ	SEM/L5*	SEM RPQ	L4	CDD
233U	234U	235U	236U	238U	
233U	234U	235U	236U		238U
238U	239Pu	240Pu	241Pu		244Pu
239Pu	240Pu	241Pu	242Pu		244Pu

Ion counter arrays for U-Pb geochronology.

CDD	CDD	SEM/L5*	SEM	CDD	
202Hg	204Pb	206Pb	207Pb	208Pb	Faraday Cup
202Hg	204Pb	206Pb	207Pb	208Pb	Ion Counter

* Dual-mode detector, switchable between Faraday and SEM.

Please contact your local sales specialist to discuss the range of configurations available.

10¹³ Ω Amplifier Technology

Extending the lower limits of the ultimate detector

Faraday cups are the detector of choice for high precision isotope ratio measurements. Ion currents can be measured to the highest degree of accuracy and precision, without the uncertainty of linearity and yield corrections. The ion current amplifiers of the Neptune XT MC-ICP-MS are mounted in a doubly shielded, evacuated housing, and temperature regulated to within 0.01 °C / hour, which guarantees stable baselines and stable gains.

The standard amplifier for MC-ICP-MS and TIMS incorporates a 10¹¹ Ω feedback resistor, accommodating a wide dynamic range of ion currents, and facilitating ppm-level isotope ratio measurement precision from high intensity ion beams. However, electronic baseline noise limits their application for low intensity ion beam measurements (<500 fA).



The proprietary 10¹³ Ω Amplifier Technology in the Neptune XT MC-ICP-MS guarantees fast response times with extremely low noise characteristics. The benefits of Faraday cups can now be realized at low signal intensities (30 kcps – 3 Mcps), delivering external precisions that approach the ultimate limits of counting statistics. The dynamic range of 10¹³ Ω Amplifier Technology extends to 30 Mcps.

Exclusive to Neptune and Triton Series instruments is a software controlled relay matrix that connects any amplifier to any Faraday cup. This enables the user to tailor the amplifier-cup configuration to the needs of each measurement.

Thermo Scientific $10^{13} \Omega$ Amplifier Technology has revolutionized the measurement of isotope ratios from low intensity ion beams, with a growing list of publications that prove the utility and performance of this technology for isotope geochemistry applications.

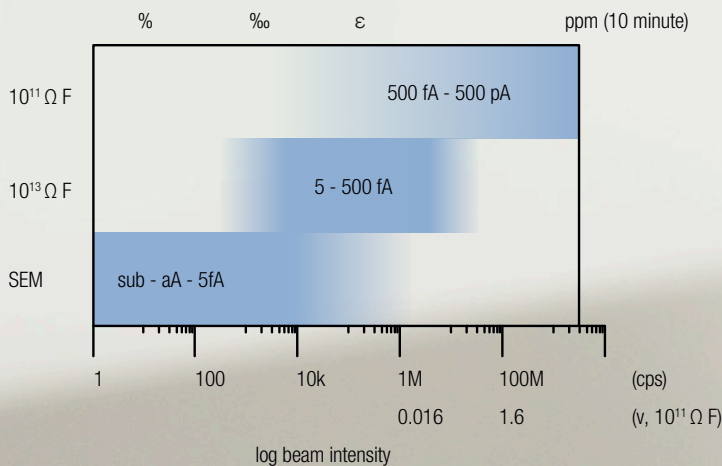

Optimum operating ranges for the three different detectors incorporated into the Neptune XT, and the level of precision that could be expected from counting statistics for a 10-minute measurement. Over 9 orders of magnitude in signal intensity range are spanned by the detector system. For intermediate signal intensities, ca. 30 kcps – 3 Mcps, $10^{13} \Omega$ Amplifier Technology is uniquely able to deliver precisions approaching the theoretical limits of counting statistics. Ion counters, such as the SEM, are recommended for the lowest signal intensities.

CASE STUDY

LA-MC-ICP-MS

Laser ablation (LA-) MC-ICP-MS is a technique that can be used to extract high precision isotope ratios directly from solids materials. Increasing spatial resolution can result in low intensity ion beams being measured. $10^{13} \Omega$ Amplifier Technology with tau correction has been demonstrated to offer up to 4x improvement in precision for laser ablation Pb isotope ratio analysis (see below). Combined with Jet Interface sensitivity, higher precisions can be achieved for smaller sampling volumes.

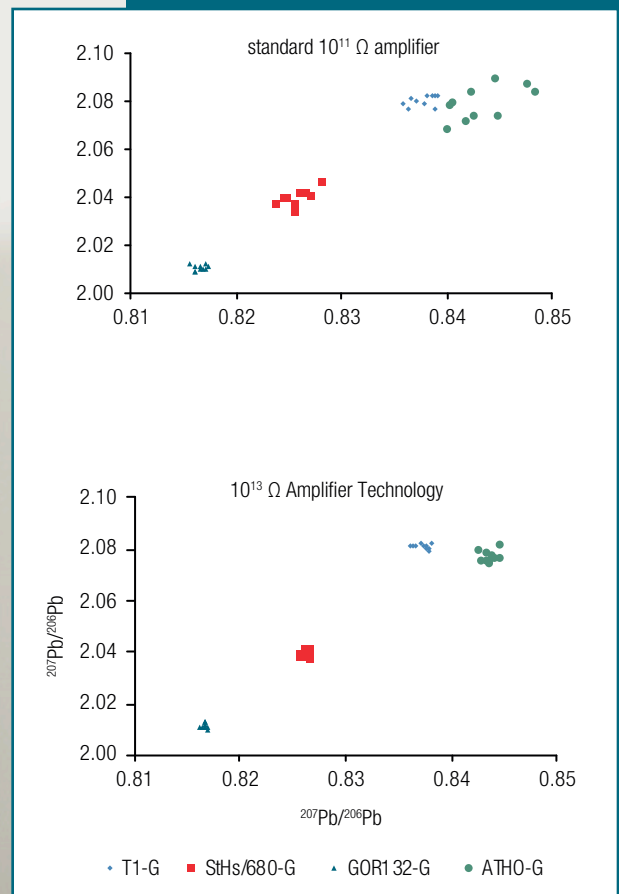

Pb isotope ratios of MPI-DING reference glasses measured by LA-MC-ICP-MS.

Top: ^{206}Pb , ^{207}Pb and ^{208}Pb measured using $10^{11} \Omega$ amplifiers. Bottom: ^{206}Pb and ^{207}Pb measured using $10^{13} \Omega$ Amplifier Technology with tau correction.

Multicollector Software Suite v3.30

$10^{13} \Omega$ Amplifier Technology made easy

The Neptune XT MC-ICP-MS is supported by a new software release. $10^{13} \Omega$ Amplifier Technology is enhanced by online tau correction, which makes $10^{13} \Omega$ Amplifier Technology as easy to use as standard Faraday cup amplifiers. Also supported is a new gain calibration option.

Until now, without additional offline corrections, the different detector response rates between $10^{13} \Omega$ Amplifier Technology and $10^{11} \Omega$ amplifiers, or ion counters, has limited the accuracy and precision that could be achieved for measurements with variable signal intensities (e.g. from laser ablation). Online tau correction now corrects for the different detector response rates, delivering accuracy and precision.

Enhanced productivity

Productivity is further enhanced by new features for the setup of long measurement sequences using Sequence Editor. With just a few clicks a long sequence of measurements can be created, including sample-standard bracketing and blank corrections.

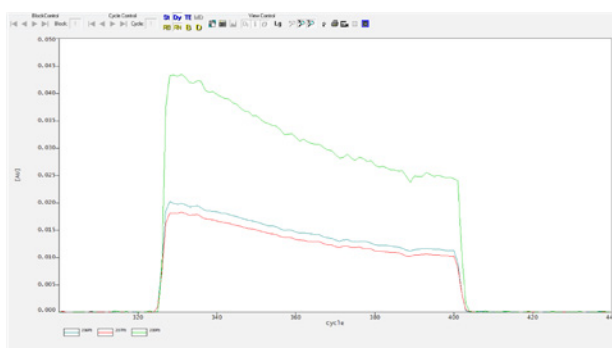
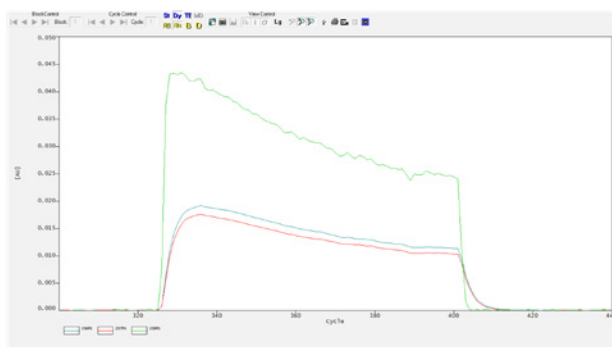

Online tau correction of signals from laser ablation Pb isotopic measurements. top: uncorrected, bottom: tau corrected. The different response rates of the amplifiers are corrected for by selecting the tau correction option in the software.





Multicollector Software Suite

Comprehensive software for MC-ICP-MS & TIMS

The Thermo Scientific Multicollector Software Suite supports scientific productivity by providing all the necessary tools for running the instrument, from setup through to results.

- **Tune** – fully automated instrument startup; straight forward control of tuning parameters and collector positioning; clear display of signal traces.
- **Method Editor** – customizable data acquisition parameters; drag and drop isotope ratio builder with built-in mass bias and interference corrections; formula editor for custom corrections.
- **Sequence Editor** – new quick setup feature for creating long measurement sequences; fully automated sequencing of methods; automated collector positioning when switching between applications; blank corrections and sample-standard comparison (delta values); online export of data; automated instrument shutdown.
- **Data Evaluation** – raw data and calculated results are displayed in spreadsheet or graphical form; evaluation parameters such as tau correction can be toggled on or off, and the data re-evaluated; raw and calculated results can be exported to a variety of data formats for further data interrogation in third party programs.

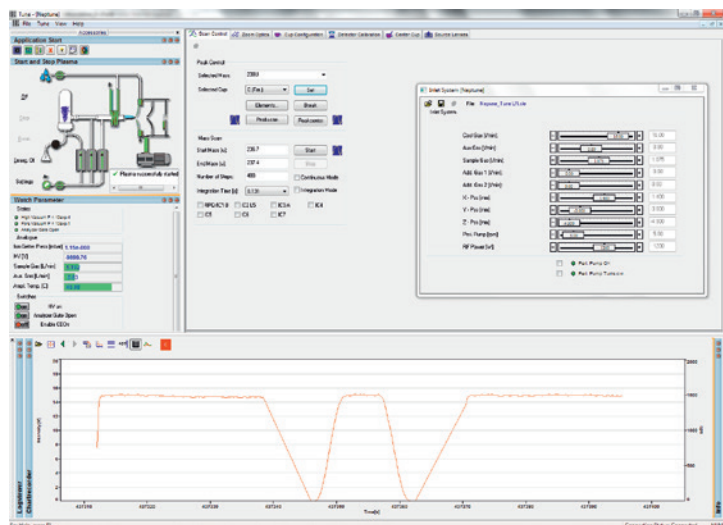
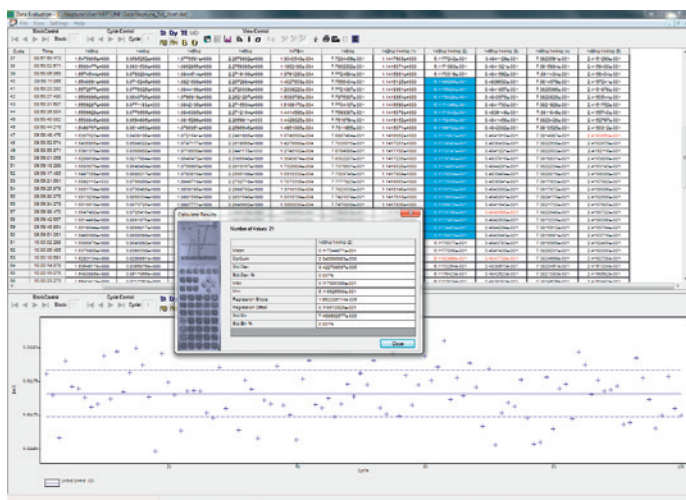

Find out more at thermofisher.com/MC-ICP-MS

© 2018 Thermo Fisher Scientific Inc. All rights reserved. All trademarks are the property of Thermo Fisher Scientific and its subsidiaries unless otherwise specified. Technologies of the Neptune XT are covered by US patents, for further information visit: <https://www.thermofisher.com/us/en/home/industrial/mass-spectrometry/virtual-patent-marks-inorganic-mass-spectrometry.html>
BR30536 EN-0718G

ThermoFisher
SCIENTIFIC